

RoHS Compliant Product  
A suffix of "-C" specifies halogen & lead-free

## FEATURES

- DTC114Y(NPN) and DTA114Y(PNP) transistors are built-in a package

## MARKING

D9

## PACKAGE INFORMATION

Package	MPQ	Leader Size
SOT-363	3K	7 inch

## ORDER INFORMATION

Part Number	Type
UMD9N-C	Lead (Pb)-free and Halogen-free

## SOT-363

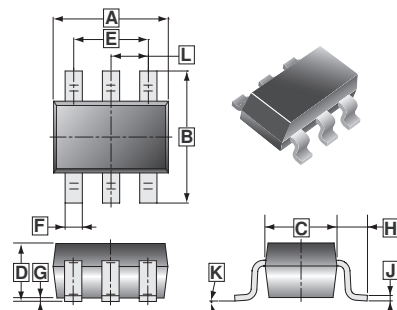

REF.	Millimeter		REF.	Millimeter	
	Min.	Max.		Min.	Max.
A	1.80	2.20	G	0.10 REF.	
B	1.80	2.45	H	0.525 REF.	
C	1.15	1.35	J	0.05	0.25
D	0.70	1.10	K	8°	
E	1.30 REF.		L	0.65 TYP.	
F	0.10	0.35			

## Mounting Pad Layout

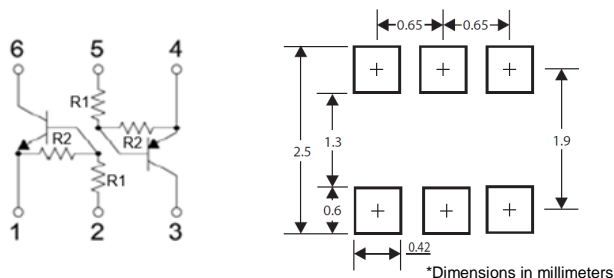

## ABSOLUTE MAXIMUM RATINGS (NPN) (T<sub>A</sub>=25°C unless otherwise specified)

Parameter	Symbol	Value	Unit
Supply Voltage	V <sub>CC</sub>	50	V
Input Voltage	V <sub>IN</sub>	-6~40	
Output Current	I <sub>O</sub>	70	mA
	I <sub>C</sub>	100	
Power Dissipation	P <sub>D</sub>	150	mW
Junction & Storage Temperature Range	T <sub>J</sub> , T <sub>STG</sub>	-55~150	°C

## ELECTRICAL CHARACTERISTICS (NPN) (T<sub>A</sub>=25°C unless otherwise specified)

Parameter	Symbol	Min.	Typ.	Max.	Unit	Test Condition
Input Voltage	V <sub>I(off)</sub>	0.3	-	-	V	V <sub>CC</sub> =5V, I <sub>O</sub> =100μA V <sub>O</sub> =0.3V, I <sub>O</sub> =1mA
	V <sub>I(on)</sub>	-	-	1.4		
Output Voltage	V <sub>O(on)</sub>	-	-	0.3		I <sub>O</sub> /I <sub>I</sub> =5mA/0.25mA
Input Current	I <sub>I</sub>	-	-	0.88	mA	V <sub>I</sub> =5V
Output Current	I <sub>O(off)</sub>	-	-	0.5	μA	V <sub>CC</sub> =50V, V <sub>I</sub> =0
DC Current Gain	G <sub>I</sub>	68	-	-	V	V <sub>O</sub> =5V, I <sub>O</sub> =5mA
Input Resistance	R <sub>1</sub>	7	10	13	kΩ	
Resistance Ratio	R <sub>2</sub> /R <sub>1</sub>	3.7	4.7	5.7		
Transition Frequency	f <sub>T</sub>	-	250	-	MHz	V <sub>CE</sub> =10V, I <sub>E</sub> =5mA, f=100MHz

**ABSOLUTE MAXIMUM RATINGS (PNP)** ( $T_A=25^\circ\text{C}$  unless otherwise specified)

Parameter	Symbol	Value	Unit
Supply Voltage	$V_{CC}$	-50	V
Input Voltage	$V_{IN}$	-40~6	
Output Current	$I_O$	-70	mA
	$I_C$	-100	
Power Dissipation	$P_D$	150	mW
Junction & Storage Temperature Range	$T_J, T_{STG}$	-55~150	$^\circ\text{C}$

**ELECTRICAL CHARACTERISTICS (PNP)** ( $T_A=25^\circ\text{C}$  unless otherwise specified)

Parameter	Symbol	Min.	Typ.	Max.	Unit	Test Condition
Input Voltage	$V_{I(off)}$	-0.3	-	-	V	$V_{CC} = -5V, I_O = -100\mu\text{A}$
	$V_{I(on)}$	-	-	-1.4		$V_O = -0.3V, I_O = -1\text{mA}$
Output Voltage	$V_{O(on)}$	-	-	-0.3		$I_O/I_I = -5\text{mA}/-0.25\text{mA}$
Input Current	$I_I$	-	-	-0.88	mA	$V_I = -5V$
Output Current	$I_{O(off)}$	-	-	-0.5	$\mu\text{A}$	$V_{CC} = -50V, V_I = 0$
DC Current Gain	$G_I$	68	-	-	V	$V_O = -5V, I_O = -5\text{mA}$
Input Resistance	$R_1$	7	10	13	k $\Omega$	
Resistance Ratio	$R_2/R_1$	3.7	4.7	5.7		
Transition Frequency	$f_T$	-	250	-	MHz	$V_{CE} = -10V, I_E = -5\text{mA}, f = 100\text{MHz}$

**CHARACTERISTICS CURVE (NPN)**

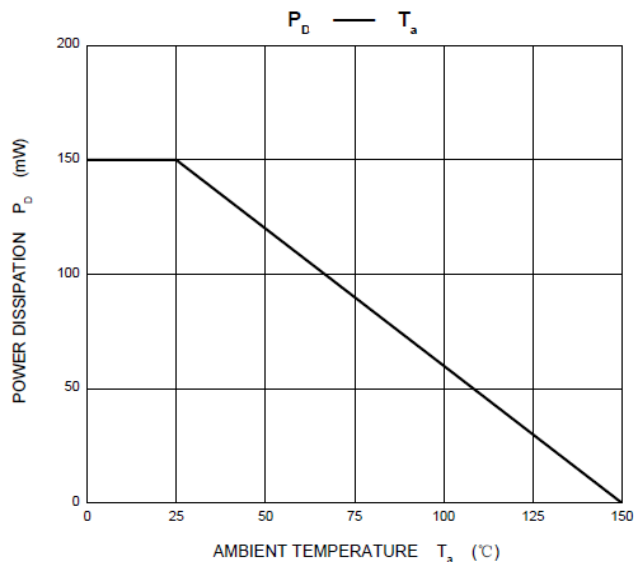
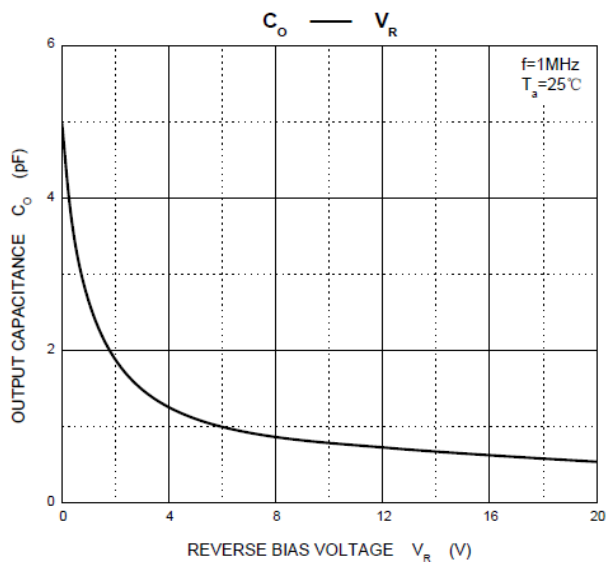
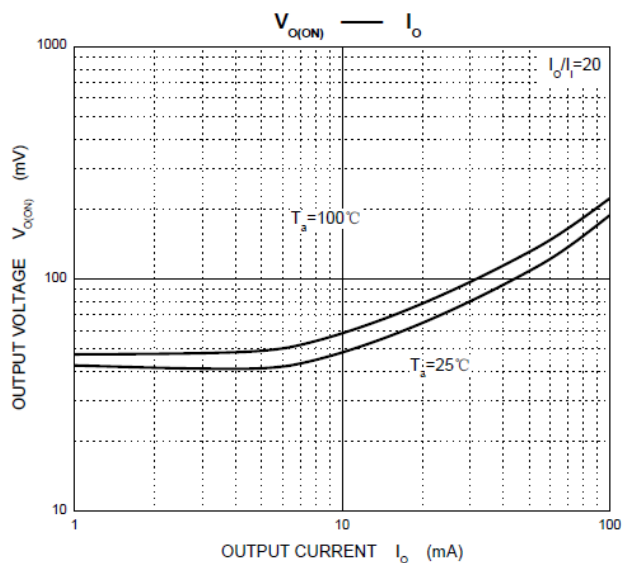
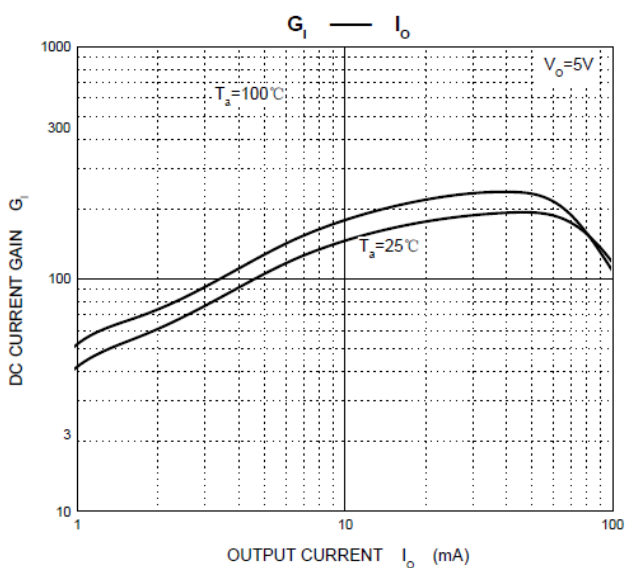
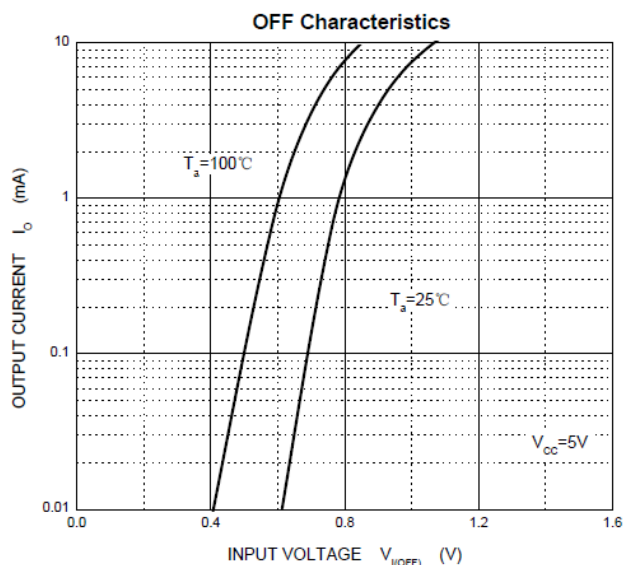
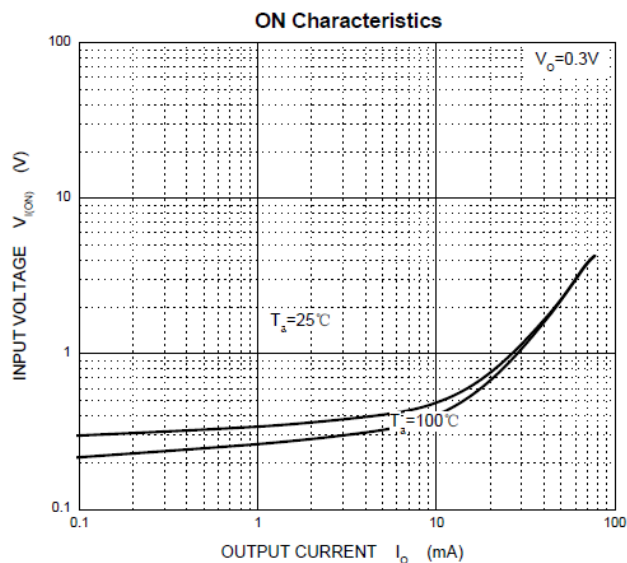

**CHARACTERISTICS CURVE (PNP)**

