

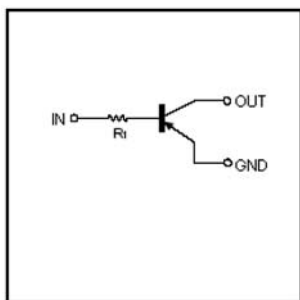

RoHS Compliant Product  
A suffix of "-C" specifies halogen & lead-free

## FEATURES

- Built-in bias resistors enable the configuration of an inverter circuit without connecting external input resistors (see equivalent circuit).
- The bias resistors consist of thin-film resistors with complete isolation to allow positive biasing of the input. They also have the advantage of almost completely eliminating parasitic effects.
- Only the on/off conditions need to be set for operation, making device design easy.

## EQUIVALENT CIRCUIT

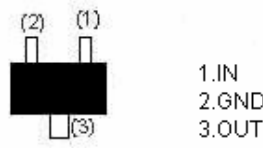
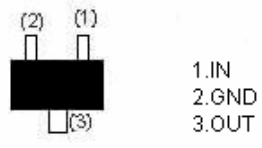
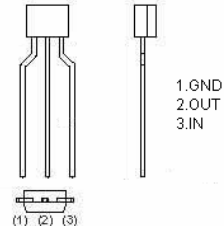

<p><b>DTA143TE (SOT-523)</b></p>  <p>1.IN 2.GND 3.OUT</p> <p>Abbreviated symbol : 93</p>	<p><b>DTA143TUA (SOT-323)</b></p>  <p>1.IN 2.GND 3.OUT</p> <p>Abbreviated symbol : 93</p>
<p><b>DTA143TSA (TO-92S)</b></p>  <p>1.GND 2.OUT 3.IN</p> <p>Abbreviated symbol : 93</p>	<p><b>DTA143TCA (SOT-23)</b></p>  <p>1.IN 2.GND 3.OUT</p> <p>Abbreviated symbol : 93</p>

## ABSOLUTE MAXIMUM RATINGS at (T<sub>A</sub> = 25°C unless otherwise noted)

Parameter	Symbol	Limits (DTA143T□)				Unit
		E	UA	CA	SA	
Collector-Base Voltage	V <sub>(BR)CBO</sub>		-50			V
Collector-Emitter Voltage	V <sub>(BR)CEO</sub>		-50			V
Emitter-Base Voltage	V <sub>(BR)EBO</sub>		-5			mV
Collector Current	I <sub>C</sub>		-100			mA
Collector Dissipation	P <sub>C</sub>	150	200		300	mW
Junction & Storage temperature	T <sub>J</sub> , T <sub>STG</sub>		150, -55~150			°C

## ELECTRICAL CHARACTERISTICS at (T<sub>A</sub> = 25°C unless otherwise noted)

Parameter	Symbol	Min.	Typ.	Max.	Unit	Test Conditions
Collector-base breakdown voltage	V <sub>(BR)CBO</sub>	-50	-	-	V	I <sub>C</sub> = -50μA
Collector-emitter breakdown voltage	V <sub>(BR)CEO</sub>	-50	-	-		I <sub>C</sub> = -1mA
Emitter-base breakdown voltage	V <sub>(BR)EBO</sub>	-5	-	-	V	I <sub>E</sub> = -50μA
Collector cut-off current	I <sub>CB0</sub>	-	-	-0.5	μA	V <sub>CB</sub> = -50V
Emitter cut-off current	I <sub>EBO</sub>	-	-	-0.5	μA	V <sub>EB</sub> = -4V
Collector-emitter saturation voltage	V <sub>CE(sat)</sub>	-	-	-0.3	V	I <sub>C</sub> = -5mA, I <sub>B</sub> = -0.25mA
DC current transfer ratio	h <sub>FE</sub>	100	-	600		V <sub>CE</sub> = -5V, I <sub>C</sub> = -1mA
Input resistance	R <sub>I</sub>	3.29	4.7	6.11	KΩ	
Transition frequency	f <sub>T</sub>	-	250	-	MHz	V <sub>CE</sub> = -10V, I <sub>E</sub> = -5mA, f = 100MHz

**CHARACTERISTIC CURVES**

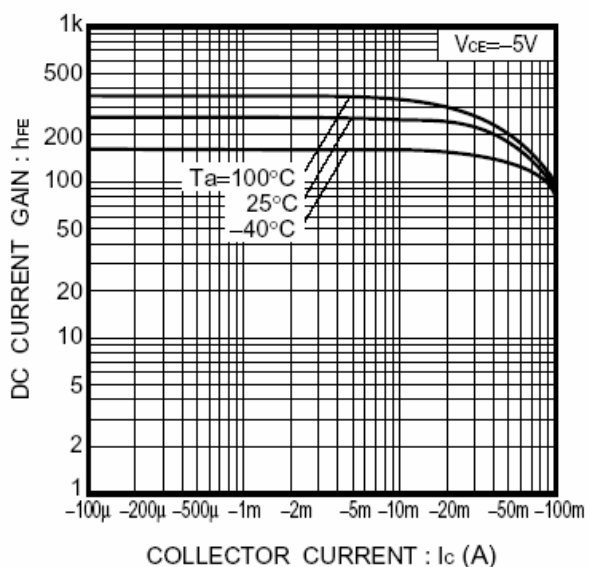

Fig.1 DC current gain vs. collector current

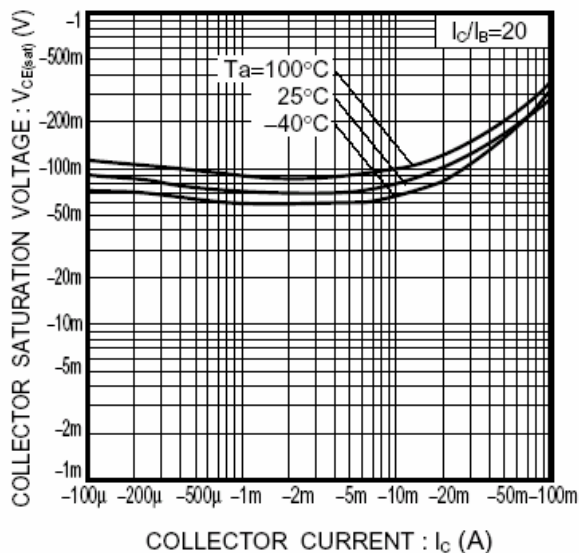

Fig.2 Collector-emitter saturation voltage vs. collector current