

RoHS Compliant Product
A suffix of "-C" specifies halogen & lead-free

FEATURES

- Low forward surge current
- Ideal for surface mounted applications
- Low leakage current

MECHANICAL DATA

- Case: JEDEC SOD-123JD, molded plastic over passivated chip
- Terminals: Solder Plated, solderable per MIL-STD-750, Method 2026
- Polarity: Color band denotes cathode end

MARKING

S34

PACKAGE INFORMATION

Package	MPQ	Leader Size
SOD-123JD	3K	7' inch

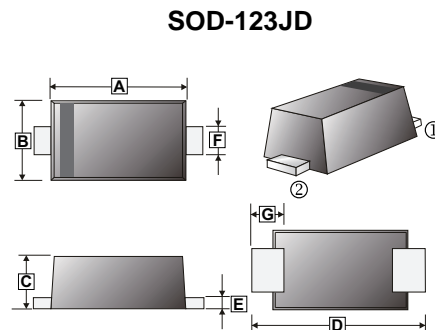

REF.	Millimeter		REF.	Millimeter	
	Min.	Max.		Min.	Max.
A	2.6	2.9	E	0.1	0.2
B	1.7	1.9	F	0.8	1.1
C	0.9	1.1	G	0.7	0.9
D	3.5	3.8			

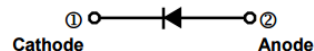

ORDER INFORMATION

Part Number	Type
SK14JD-C	Lead (Pb)-free and Halogen-free

MAXIMUM RATINGS AND ELECTRICAL CHARACTERISTICS (Rating 25°C ambient temperature unless otherwise specified. Single phase, half wave, 60Hz, resistive or inductive load. For capacitive load, de-rate current by 20%.)

Parameter	Symbol	Rating	Unit
Maximum Recurrent Reverse Voltage	V_{RRM}	40	V
Maximum RMS Voltage	V_{RMS}	28	V
Maximum DC Blocking Voltage	V_{DC}	40	V
Maximum Average Forward Rectified Current	$I_{(AV)}$	1	A
Peak Forward Surge Current 8.3ms single half sine-wave superimposed on rated load (JEDEC method)	I_{FSM}	80	A
Typical thermal resistance junction to Lead ²	$R_{\theta JL}$	20	°C / W
Typical thermal resistance junction to Case ²	$R_{\theta JC}$	40	°C / W
Operating & Storage Temperature Range	T_J, T_{STG}	-55~125, -55~150	°C

ELECTRICAL CHARACTERISTICS

Parameter	Symbol	Typ.	Max.	Unit	Test Condition
Maximum Instantaneous Forward Voltage	V_F	0.38	-	V	$I_F=500mA$
		0.41	-		$I_F=1A$
		-	0.55		$I_F=3A$
Maximum DC Reverse Current at Rated DC Blocking Voltage ²	I_R	-	0.5	mA	$T_A=25^\circ C$
		-	10		$T_A=100^\circ C$
Typical Junction Capacitance ¹	C_J	250	-	pF	

Notes:

1. Measured at $f=1.0MHz$, $V_R=4.0V$
2. FR4 Board Heat sink size: $10*10*0.2mm$.

CHARACTERISTIC CURVES

Fig.1 Forward Current Derating Curve

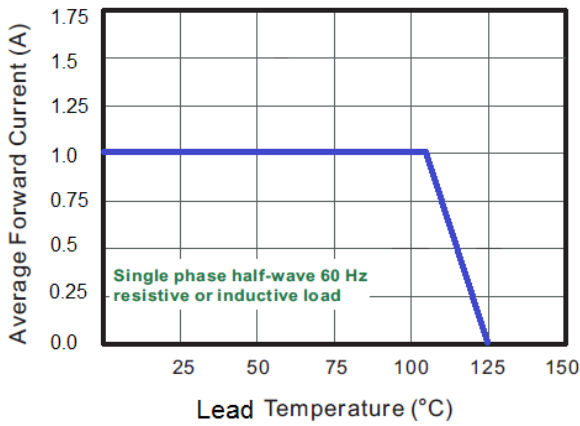

Fig.2 Typical Reverse Characteristics

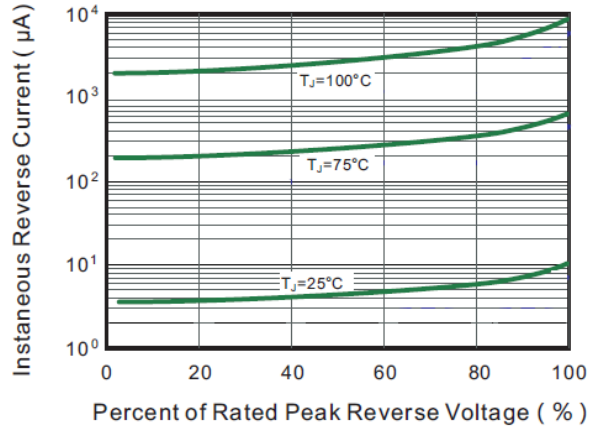

Fig.3 Typical Forward Characteristic

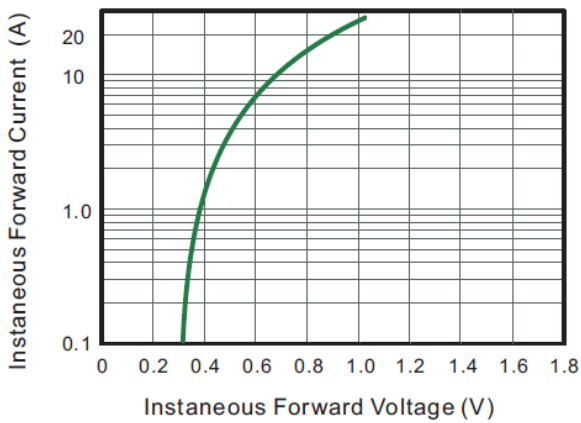

Fig.4 Typical Junction Capacitance

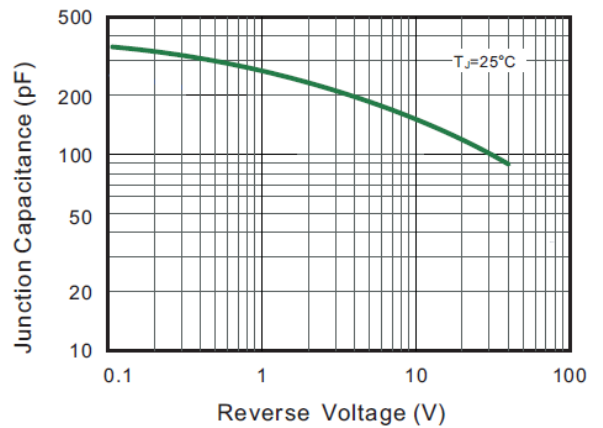

Fig.5 Maximum Non-Repetitive Peak Forward Surge Current

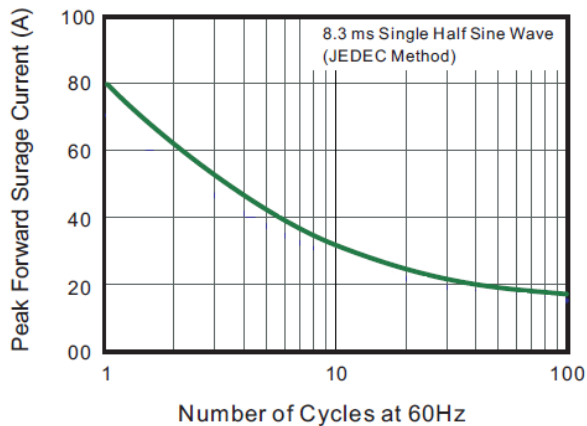

Fig.6- Typical Transient Thermal Impedance

