

RoHS Compliant Product
A suffix of "-C" specifies halogen free

DESCRIPTION

The SSQF50N10SV-C is the Shielded Gate Technology N-ch MOSFETs with extreme high cell density, which provide excellent $R_{DS(ON)}$ and gate charge for most of the synchronous buck converter applications.

The SSQF50N10SV-C meet the RoHS and Green Product requirement with full function reliability approved.

FEATURES

- Shielded Gate Trench Technology
- Super Low Gate Charge
- Green Device Available

MARKING

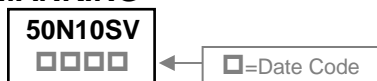

ORDER INFORMATION

Part Number	Type
SSQF50N10SV-C	Lead (Pb)-free and Halogen-free

ITO-220J

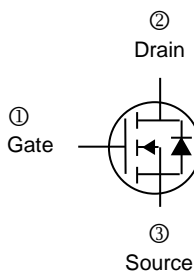
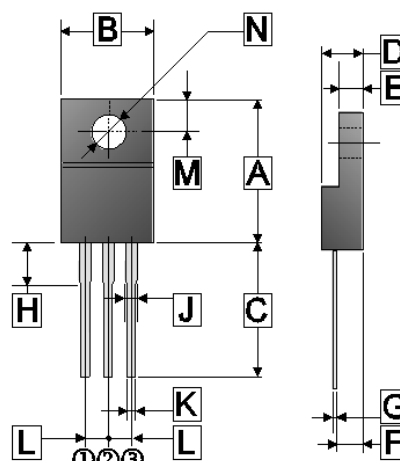

REF.	Millimeter		REF.	Millimeter	
	Min.	Max.		Min.	Max.
A	14.50	15.50	H	3.80	TYP.
B	9.50	10.50	J	1.30	REF.
C	13.20	REF.	K	0.30	0.90
D	4.24	4.84	L	2.54	REF.
E	2.52	3.20	M	2.70	REF.
F	2.50	2.90	N	ϕ 3.50	REF.
G	0.47	0.75			

ABSOLUTE MAXIMUM RATINGS ($T_A=25^\circ\text{C}$ unless otherwise specified)

Parameter	Symbol	Ratings	Unit
Drain-Source Voltage	V_{DS}	100	V
Gate-Source Voltage	V_{GS}	± 20	V
Continuous Drain Current ¹ @ $V_{GS}=10\text{V}$	I_D	$T_C=25^\circ\text{C}$	50
		$T_C=100^\circ\text{C}$	32
Pulsed Drain Current ²	I_{DM}	120	A
Total Power Dissipation ³	P_D	29.7	W
Operating Junction & Storage Temperature Range	T_J, T_{STG}	-55~150	$^\circ\text{C}$
Thermal Resistance Ratings			
Maximum Thermal Resistance Junction-Ambient ¹	$R_{\theta JA}$	62	$^\circ\text{C/W}$
Maximum Thermal Resistance Junction-Case ¹	$R_{\theta JC}$	4.2	

ELECTRICAL CHARACTERISTICS ($T_J=25^\circ\text{C}$ unless otherwise specified)

Parameter	Symbol	Min.	Typ.	Max.	Unit	Test conditions	
Drain-Source Breakdown Voltage	BV_{DSS}	100	-	-	V	$V_{GS}=0V, I_D=250\mu A$	
Gate Threshold Voltage	$V_{GS(th)}$	2	-	4	V	$V_{DS}=V_{GS}, I_D=250\mu A$	
Forward Transfer Conductance	g_{fs}	-	80	-	S	$V_{DS}=5V, I_D=20A$	
Gate-Source Leakage Current	I_{GSS}	-	-	± 100	nA	$V_{GS}=\pm 20V$	
Drain-Source Leakage Current	I_{DSS}	$T_J=25^\circ\text{C}$	-	-	1	μA	$V_{DS}=80V, V_{GS}=0$
		$T_J=55^\circ\text{C}$	-	-	5		$V_{DS}=80V, V_{GS}=0$
Static Drain-Source On-Resistance ²	$R_{DS(ON)}$	-	5.8	8.4	m Ω	$V_{GS}=10V, I_D=13.5A$	
Total Gate Charge	Q_g	-	52	-	nC	$I_D=20A$ $V_{DS}=50V$ $V_{GS}=10V$	
Gate-Source Charge	Q_{gs}	-	13.5	-			
Gate-Drain ("Miller") Change	Q_{gd}	-	16	-			
Turn-on Delay Time	$T_{d(on)}$	-	10	-	nS	$V_{DD}=50V$ $I_D=13.5A$ $V_{GS}=10V$ $R_G=3\Omega$	
Rise Time	T_r	-	6.5	-			
Turn-off Delay Time	$T_{d(off)}$	-	45	-			
Fall Time	T_f	-	7.5	-			
Input Capacitance	C_{iss}	-	3148	-	pF	$V_{GS}=0V$ $V_{DS}=50V$ $f=1MHz$	
Output Capacitance	C_{oss}	-	693	-			
Reverse Transfer Capacitance	C_{rss}	-	26	-			
Source-Drain Diode							
Diode Forward Voltage ²	V_{SD}	-	-	1.2	V	$I_S=1A, V_{GS}=0V$	
Continuous Source Current ¹	I_S	-	-	50	A		
Reverse Recovery Time	t_{rr}	-	33	-	nS	$I_F=13.5A, dI/dt=100A/\mu s,$	
Reverse Recovery Charge	Q_{rr}	-	150	-	nC	$T_J=25^\circ\text{C}$	

Notes:

1. The data tested by surface mounted on a 1 inch² FR-4 board with 2OZ copper.
2. The data tested by pulsed, Pulse Width $\leq 300\mu s$, Duty Cycle $\leq 2\%$.
3. The power dissipation is limited by 150 $^\circ\text{C}$ junction temperature.

TYPICAL CHARACTERISTICS CURVE

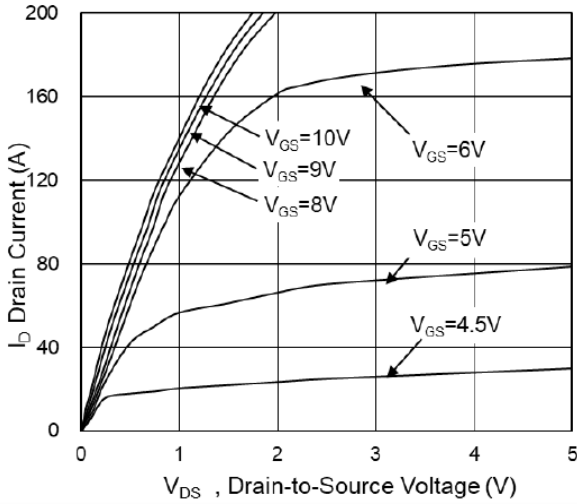

Fig.1 Typical Output Characteristics

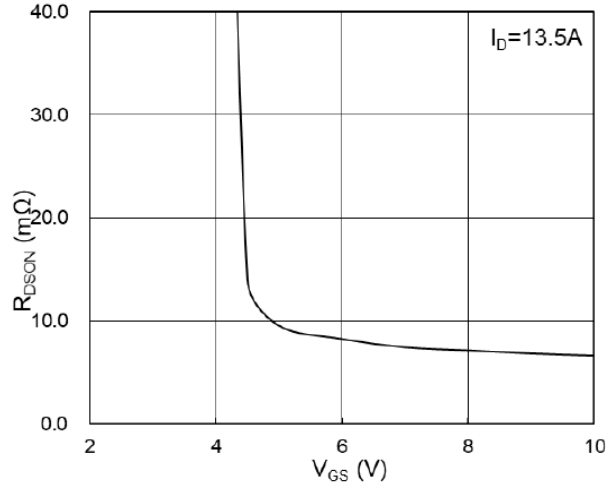

Fig.2 On-Resistance vs G-S Voltage

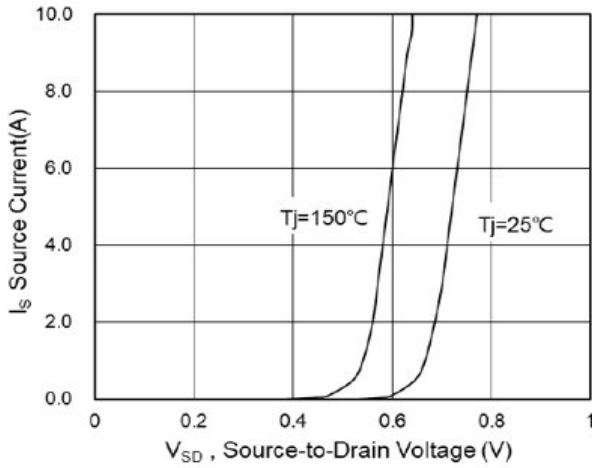

Fig.3 Source-Drain Forward Characteristics

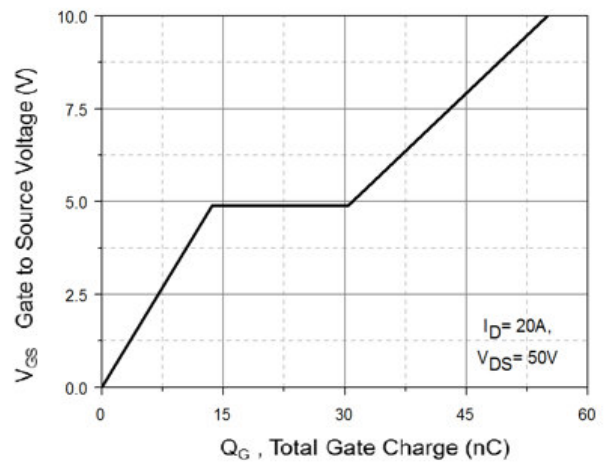

Fig.4 Gate-Charge Characteristics

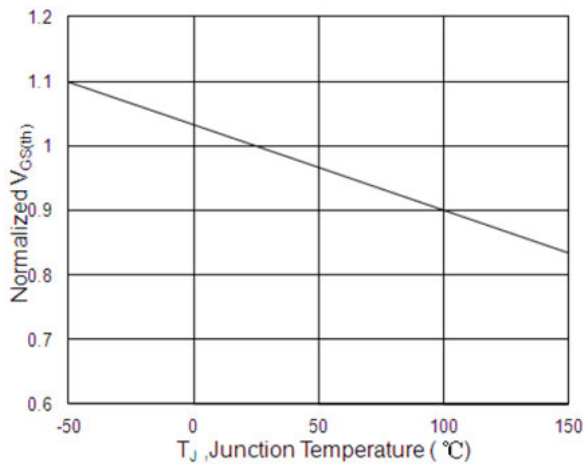

Fig.5 Normalized $V_{GS(th)}$ vs T_J

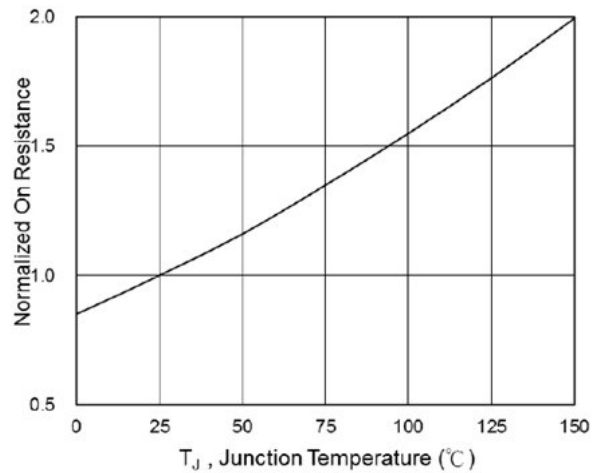

Fig.6 Normalized $R_{DS(on)}$ vs T_J

TYPICAL CHARACTERISTICS CURVE

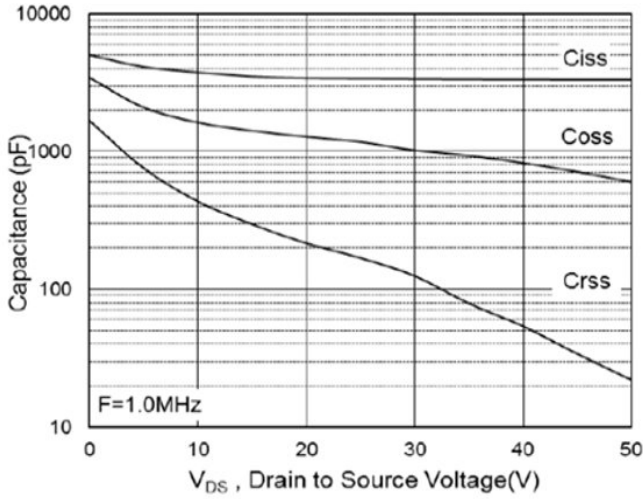

Fig.7 Capacitance

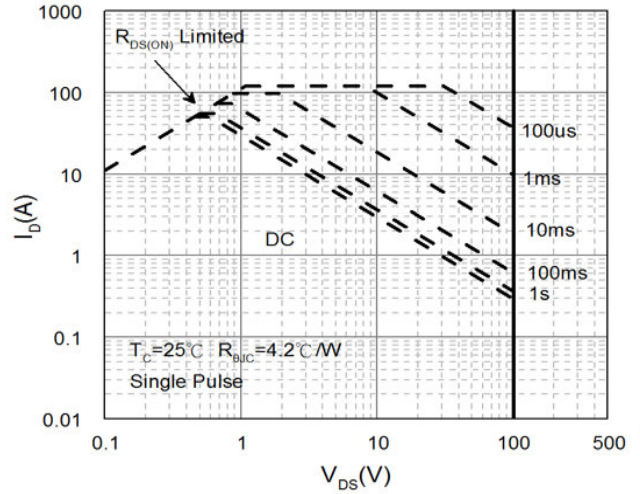

Fig.8 Safe Operating Area

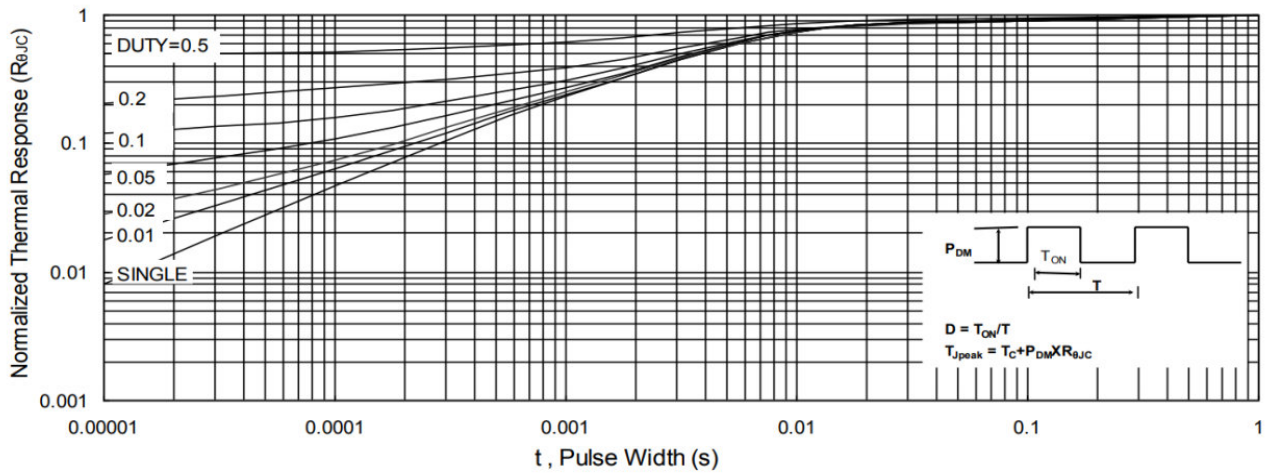

Fig.9 Normalized Maximum Transient Thermal Impedance

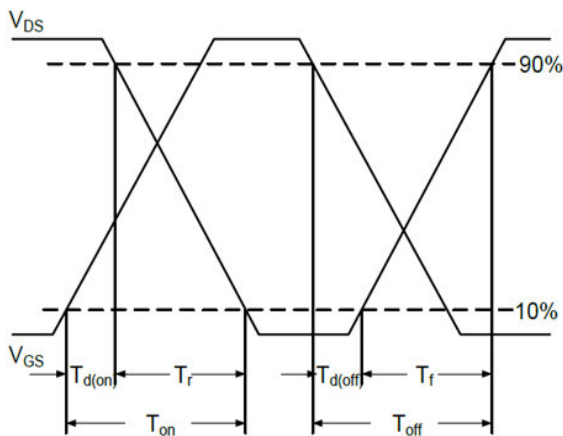

Fig.10 Switching Time Waveform

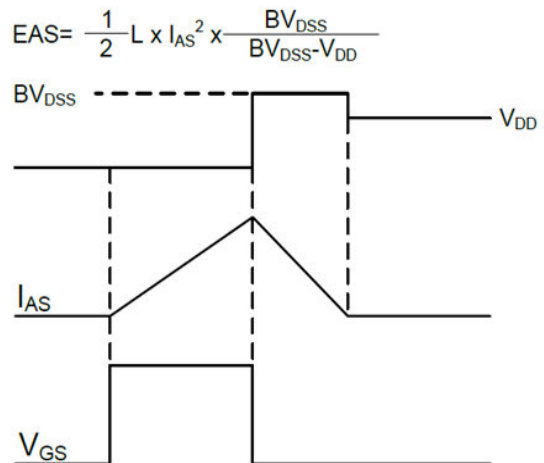

Fig.11 Unclamped Inductive Switching Waveform