

RoHS Compliant Product  
A suffix of "-C" specifies halogen free

## DESCRIPTION

The SSD1K7N70H-C is power MOSFET using Super Junction technology that can realize very low on-resistance and gate charge. It will provide much high efficiency by using optimized charge coupling technology. These user friendly devices give an advantage of low EMI to designers as well as low switching loss, which provide excellent  $R_{DS(ON)}$  and gate charge for most of the synchronous buck converter applications.

The SSD1K7N70H-C meet the RoHS and Green Product requirement with full function reliability approved.

## FEATURES

- Advanced Super Junction Technology
- Super Low Gate Charge
- Green Device Available

## MARKING

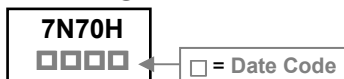

## PACKAGE INFORMATION

Package	MPQ	Leader Size
TO-252	2.5K	13 inch

## ORDER INFORMATION

Part Number	Type
SSD1K7N70H-C	Lead (Pb)-free and Halogen-free

## ABSOLUTE MAXIMUM RATINGS

Parameter	Symbol	Ratings	Unit
Drain-Source Voltage	$V_{DS}$	700	V
Gate-Source Voltage	$V_{GS}$	$\pm 30$	V
Continuous Drain Current <sup>1</sup> @ $V_{GS}=10V$	$I_D$	$T_C=25^\circ C$	4.5
		$T_C=100^\circ C$	3.2
Pulsed Drain Current <sup>3</sup>	$I_{DM}$	26	A
Total Power Dissipation <sup>1</sup>	$P_D$	52	W
Operating Junction and Storage Temperature Range	$T_J, T_{STG}$	-55~150	$^\circ C$
<b>Thermal Resistance Ratings</b>			
Maximum Thermal Resistance Junction-Ambient <sup>1</sup>	$R_{\theta JA}$	62.5	$^\circ C/W$
Maximum Thermal Resistance Junction-Ambient <sup>2</sup>		110	
Maximum Thermal Resistance Junction-Case	$R_{\theta JC}$	2.4	

## TO-252(D-Pack)

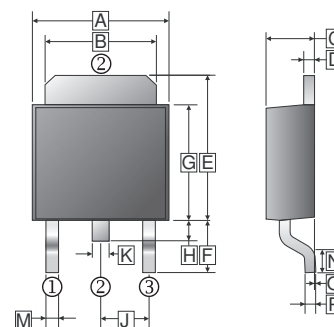
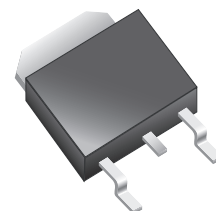

REF.	Millimeter		REF.	Millimeter	
	Min.	Max.		Min.	Max.
A	6.3	6.9	J	2.3	REF.
B	4.95	5.53	K	0.89	REF.
C	2.1	2.5	M	0.45	1.14
D	0.4	0.9	N	1.55	Typ.
E	6	7.7	O	0	0.15
F	2.90	REF.	P	0.58	REF.
G	5.4	6.4			
H	0.6	1.2			

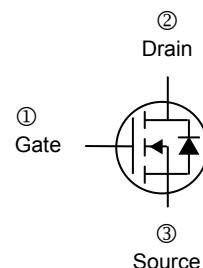

**ELECTRICAL CHARACTERISTICS** ( $T_J=25^\circ\text{C}$  unless otherwise specified)

Parameter	Symbol	Min.	Typ.	Max.	Unit	Test Conditions
Drain-Source Breakdown Voltage	$BV_{DSS}$	700	-	-	V	$V_{GS}=0, I_D=250\mu\text{A}$
Gate Threshold Voltage	$V_{GS(th)}$	2	-	4	V	$V_{DS}=V_{GS}, I_D=250\mu\text{A}$
Gate-Source Leakage Current	$I_{GSS}$	-	-	$\pm 100$	nA	$V_{GS}=\pm 30\text{V}$
Drain-Source Leakage Current	$I_{DSS}$	-	-	1	$\mu\text{A}$	$V_{DS}=560\text{V}, V_{GS}=0$
Static Drain-Source On-Resistance <sup>4</sup>	$R_{DS(ON)}$	-	1.5	1.7	$\Omega$	$V_{GS}=10\text{V}, I_D=1\text{A}$
Total Gate Charge	$Q_g$	-	6.1	-	nC	$I_D=1\text{A}$ $V_{DS}=560\text{V}$ $V_{GS}=10\text{V}$
Gate-Source Charge	$Q_{gs}$	-	1.3	-		
Gate-Drain Charge	$Q_{gd}$	-	3.3	-		
Turn-on Delay Time	$T_{d(on)}$	-	11	-	nS	$V_{DS}=350\text{V}$ $I_D=1\text{A}$ $V_{GS}=10\text{V}$ $R_G=25\Omega$
Rise Time	$T_r$	-	25	-		
Turn-off Delay Time	$T_{d(off)}$	-	30	-		
Fall Time	$T_f$	-	24	-		
Input Capacitance	$C_{iss}$	-	225	-	pF	$V_{GS}=0\text{V}$ $V_{DS}=25\text{V}$ $f=1\text{MHz}$
Output Capacitance	$C_{oss}$	-	300	-		
Reverse Transfer Capacitance	$C_{rss}$	-	12	-		
<b>Source-Drain Diode</b>						
Continuous Source Current <sup>1</sup>	$I_S$	-	-	4.5	A	
Pulsed Source Current <sup>3</sup>	$I_{SM}$	-	-	28	A	
Diode Forward Voltage <sup>4</sup>	$V_{SD}$	-	-	1.4	V	$I_S=1\text{A}, V_{GS}=0$
Reverse Recovery Time	$T_{rr}$	-	358	-	nS	$I_F=1\text{A}, dI/dt=100\text{A}/\mu\text{s},$ $V_{DD}=100\text{V}, T_J=25^\circ\text{C}$
Reverse Recovery Charge	$Q_{rr}$	-	1.5	-	nC	

Notes:

1. Surface Mounted on 1inch<sup>2</sup> FR4 Board with 2OZ copper.
2. When mounted on Min. copper pad.
3. Pulse Width limited by maximum junction temperature, pulse width  $\leq 10\mu\text{s}$ , duty cycle  $\leq 2\%$ .
4. The data tested by pulsed, Pulse Width  $\leq 300\mu\text{s}$ , Duty Cycle  $\leq 2\%$ .

**TYPICAL CHARACTERISTICS CURVE**

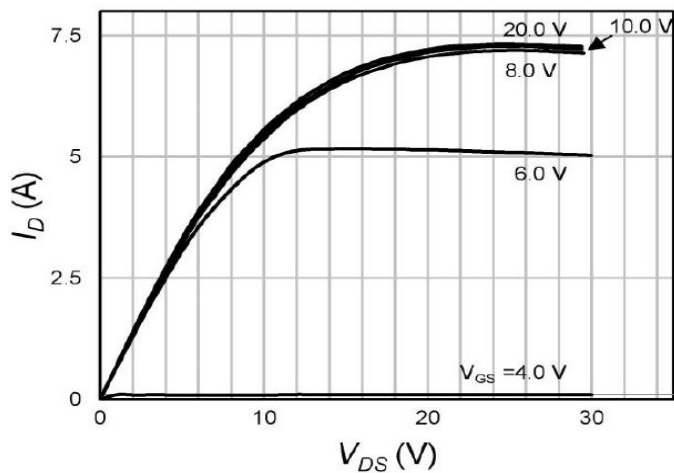

**Fig.1 Typical Output Characteristics**

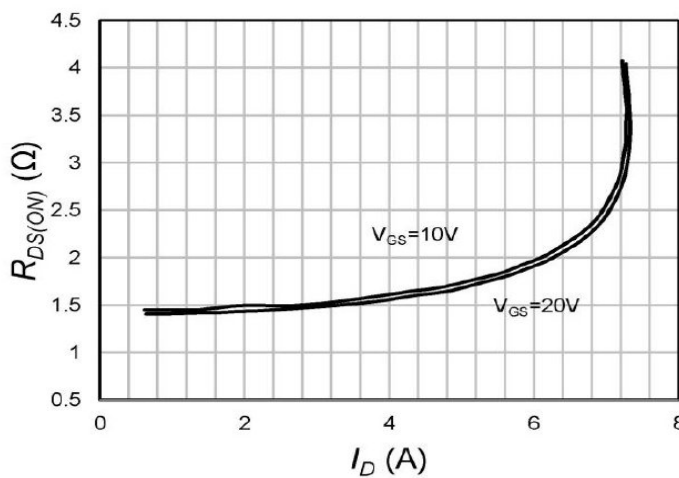

**Fig.2 On-Resistance vs. Drain Current**

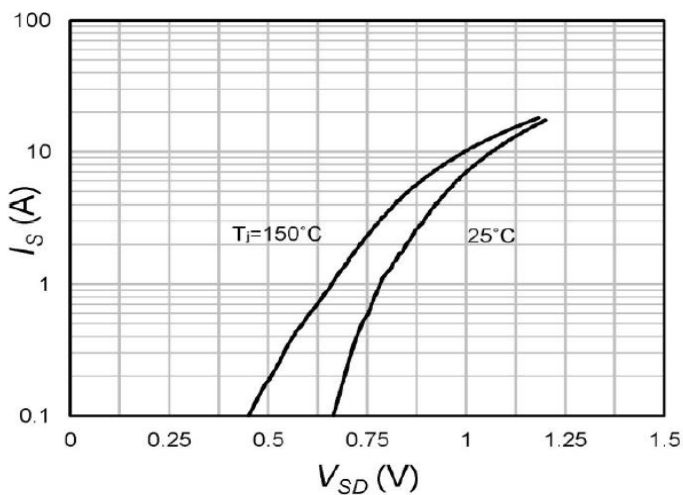

**Fig.3 Forward Characteristics of Reverse**

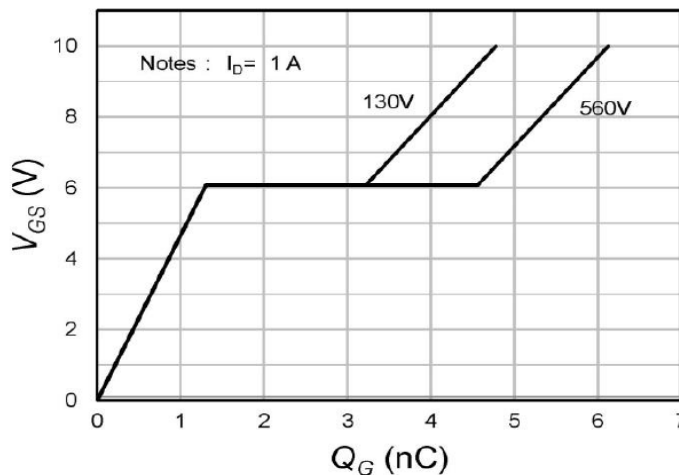

**Fig.4 Gate-Charge Characteristics**

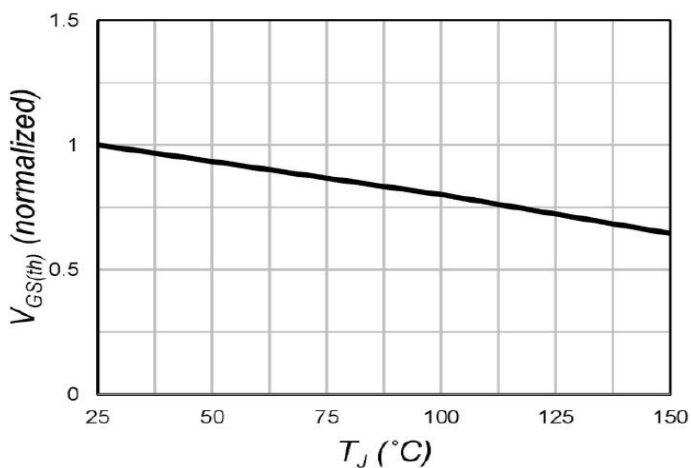

**Fig.5 Normalized  $V_{GS(th)}$  vs.  $T_J$**

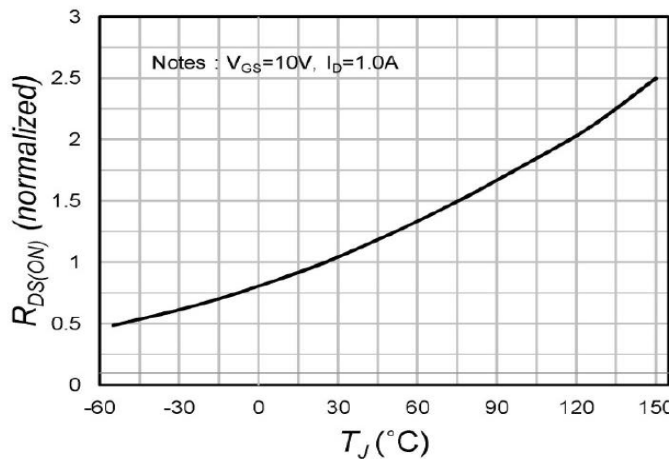

**Fig.6 Normalized  $R_{DS(ON)}$  vs.  $T_J$**

**TYPICAL CHARACTERISTICS CURVE**

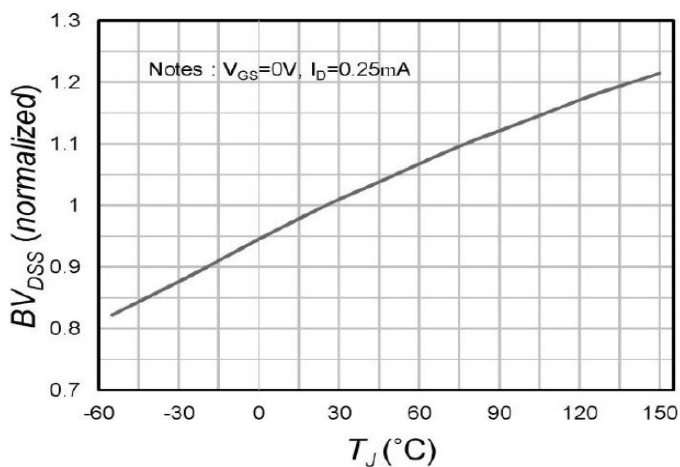

Fig.7 Drain-Source Breakdown Voltage(Normazied)

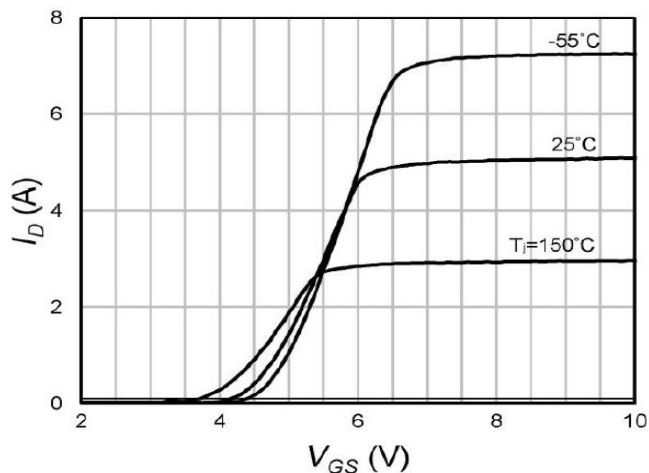

Fig.8 Transfer Characteristics

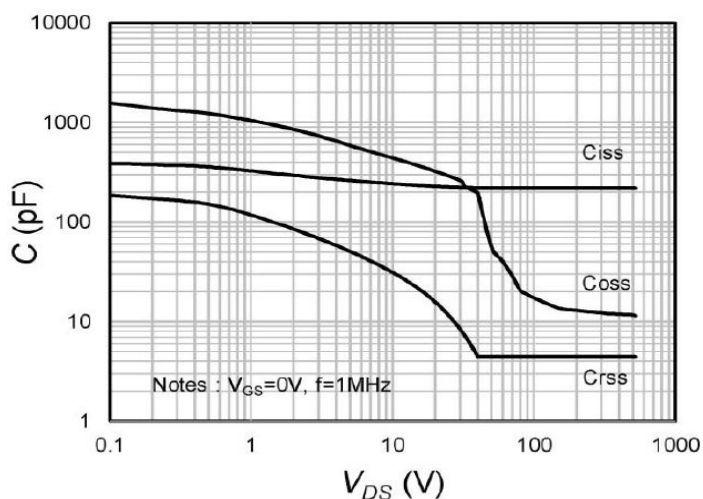

Fig.9 Capacitances

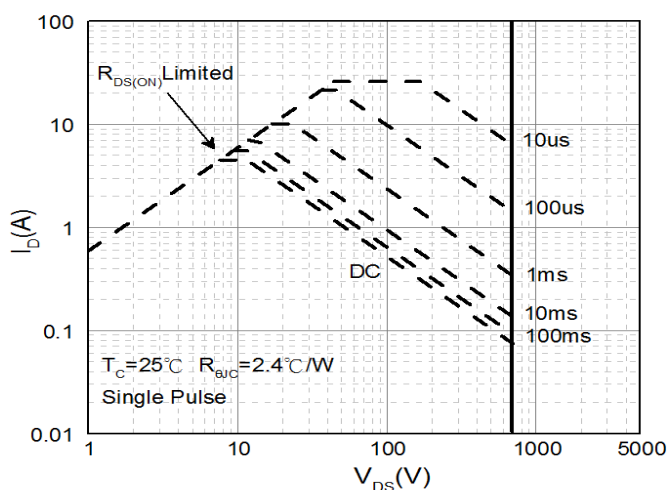

Fig.10 Safe Operating Area

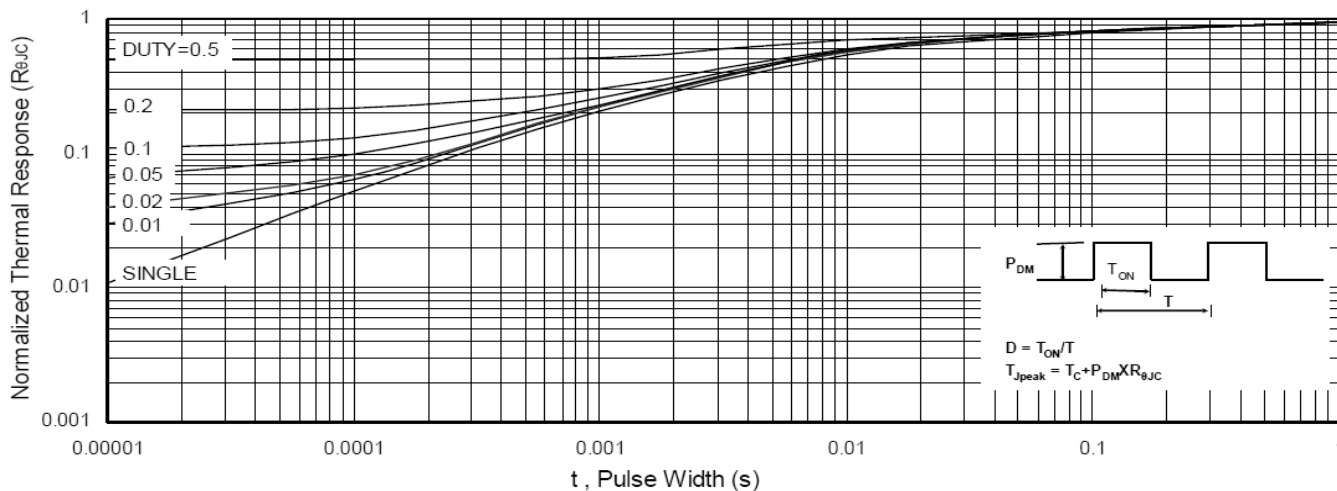

Fig.11 Normalized Maximum Transient Thermal Impedance