

RoHS Compliant Product
A suffix of "-C" specifies halogen free

DESCRIPTION

The SSU89N10SV-C is the Shielded Gate Technology N-ch MOSFETs with extreme high cell density, which provide excellent $R_{DS(ON)}$ and gate charge for most of the synchronous buck converter applications.

The SSU89N10SV-C meet the RoHS and Green Product requirement with full function reliability approved.

FEATURES

- Shielded Gate Trench Technology
- Super Low Gate Charge
- Green Device Available

MARKING



PACKAGE INFORMATION

Package	MPQ	Leader Size
TO-263	0.8K	13 inch

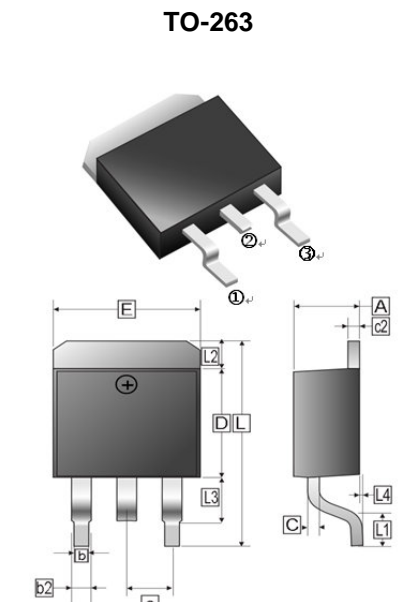

REF.	Millimeter		REF.	Millimeter	
	Min.	Max.		Min.	Max.
A	4.00	4.87	c2	1.07	1.65
b	0.51	1.01	b2	1.34	REF.
L4	0	0.30	D	8	9.65
C	0.30	0.74	e	2.54	REF.
L3	1.50	REF.	L	14.60	16.10
L1	2.50	REF.	L2	1.27	REF.
E	9.60	10.67			

ORDER INFORMATION

Part Number	Type
SSU89N10SV-C	Lead (Pb)-free and Halogen-free

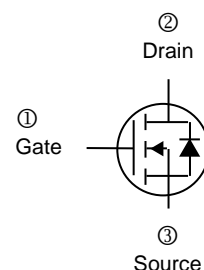

ABSOLUTE MAXIMUM RATINGS ($T_A=25^\circ\text{C}$ unless otherwise specified)

Parameter	Symbol	Rating	Unit
Drain-Source Voltage	V_{DS}	100	V
Gate-Source Voltage	V_{GS}	± 20	V
Continuous Drain Current ¹ @ $V_{GS}=10\text{V}$	$T_C=25^\circ\text{C}$	89	A
	$T_C=100^\circ\text{C}$	56	
Pulsed Drain Current ²	I_{DM}	220	A
Power Dissipation ³	P_D	111.6	W
Operating Junction & Storage Temperature Range	T_J, T_{STG}	-55~150	$^\circ\text{C}$
Thermal Resistance Rating			
Thermal Resistance Junction-Ambient ¹	$R_{\theta JA}$	62	$^\circ\text{C/W}$
Thermal Resistance Junction-Case ¹	$R_{\theta JC}$	1.12	

ELECTRICAL CHARACTERISTICS ($T_J=25^\circ C$ unless otherwise specified)

Parameter	Symbol	Min.	Typ.	Max.	Unit	Test Conditions
Drain-Source Breakdown Voltage	$V_{(BR)DSS}$	100	-	-	V	$V_{GS}=0V, I_D=250\mu A$
Gate-Threshold Voltage	$V_{GS(th)}$	2	-	4	V	$V_{DS}=V_{GS}, I_D=250\mu A$
Forward Transfer Conductance	g_{fs}	-	80	-	S	$V_{DS}=5V, I_D=20A$
Gate-Source Leakage Current	I_{GSS}	-	-	± 100	nA	$V_{GS}=\pm 20V$
Drain-Source Leakage Current	I_{DSS}	-	-	1	μA	$V_{DS}=80V, V_{GS}=0V$
		-	-	5		$V_{DS}=80V, V_{GS}=0V$
Static Drain-Source On-Resistance ²	$R_{DS(ON)}$	-	6.6	8.8	$m\Omega$	$V_{GS}=10V, I_D=13.5A$
Total Gate Charge	Q_g	-	52	-	nC	$I_D=20A$ $V_{DS}=50V$ $V_{GS}=10V$
Gate-Source Charge	Q_{gs}	-	13.5	-		
Gate-Drain Change	Q_{gd}	-	16	-		
Turn-on Delay Time	$T_{d(on)}$	-	10	-	nS	$V_{DD}=50V$ $I_D=13.5A$ $V_{GS}=10V$ $R_G=3\Omega$
Rise Time	T_r	-	6.5	-		
Turn-off Delay Time	$T_{d(off)}$	-	45	-		
Fall Time	T_f	-	7.5	-		
Input Capacitance	C_{iss}	-	3148	-	pF	$V_{GS}=0V$ $V_{DS}=50V$ $f=1MHz$
Output Capacitance	C_{oss}	-	693	-		
Reverse Transfer Capacitance	C_{rss}	-	26	-		
Source-Drain Diode						
Diode Forward Voltage ²	V_{SD}	-	-	1.2	V	$I_S=1A, V_{GS}=0V$
Continuous Source Current ¹	I_S	-	-	89	A	$V_G=V_D=0$, Force Current
Reverse Recovery Time	T_{rr}	-	33	-	nS	$I_F=13.5A, di/dt=100A/\mu s,$ $T_J=25^\circ C$
Reverse Recovery Charge	Q_{rr}	-	150	-	nC	

Notes:

1. The data tested by surface mounted on a 1 inch² FR-4 board with 2OZ copper.
2. The data tested by pulsed pulse width $\leq 300\mu s$, duty cycle $\leq 2\%$.
3. The power dissipation is limited by 150°C junction temperature.

CHARACTERISTIC CURVES

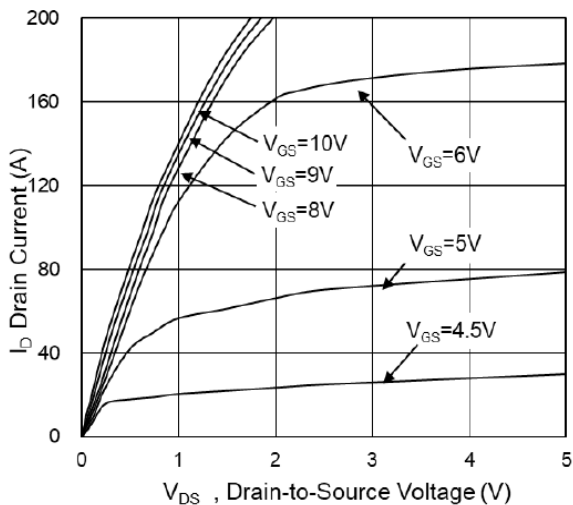

Fig.1 Typical Output Characteristics

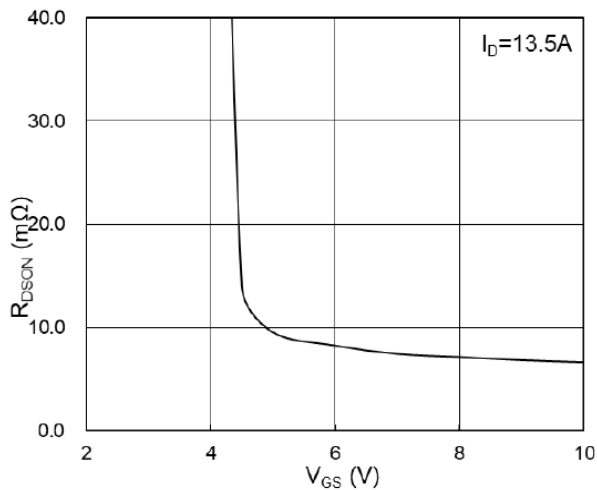

Fig.2 On-Resistance vs G-S Voltage

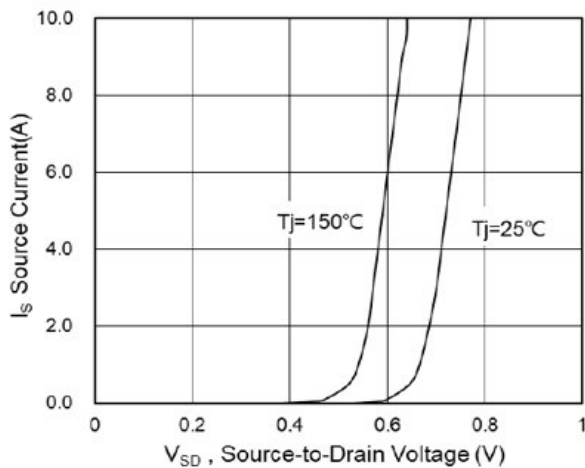

Fig.3 Source-Drain Forward Characteristics

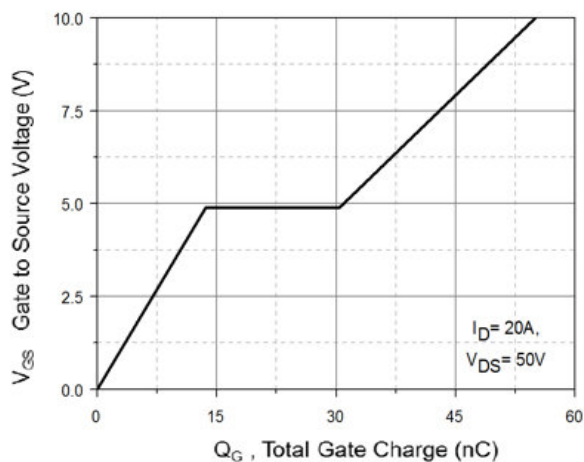

Fig.4 Gate-Charge Characteristics

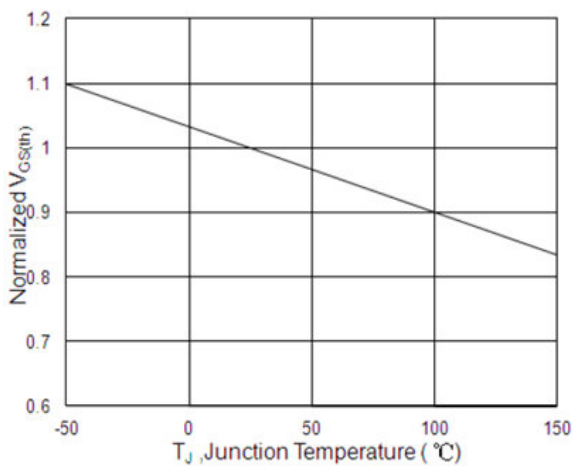

Fig.5 Normalized $V_{GS(th)}$ vs T_J

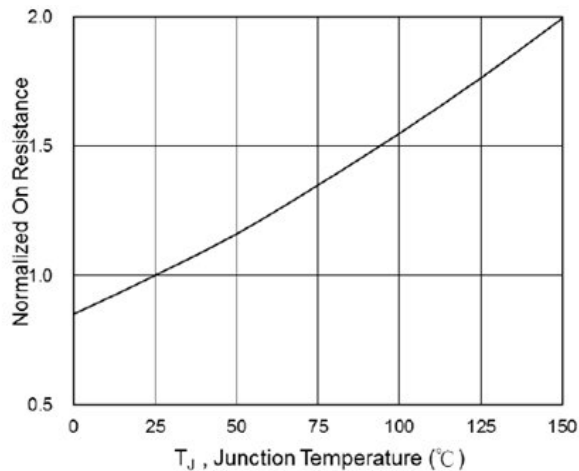

Fig.6 Normalized $R_{DS(ON)}$ vs T_J

CHARACTERISTIC CURVES

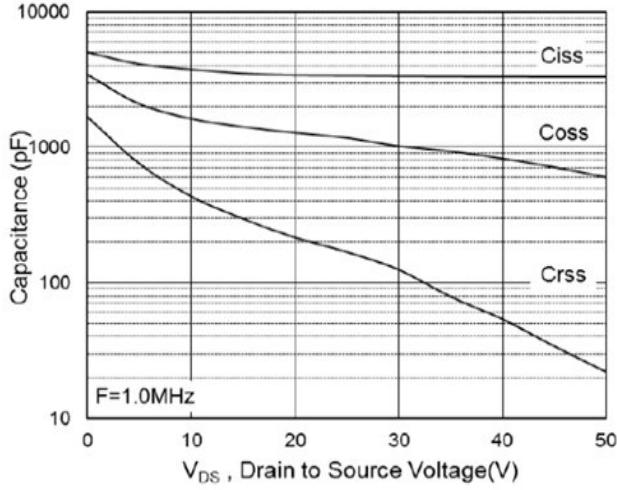

Fig.7 Capacitance

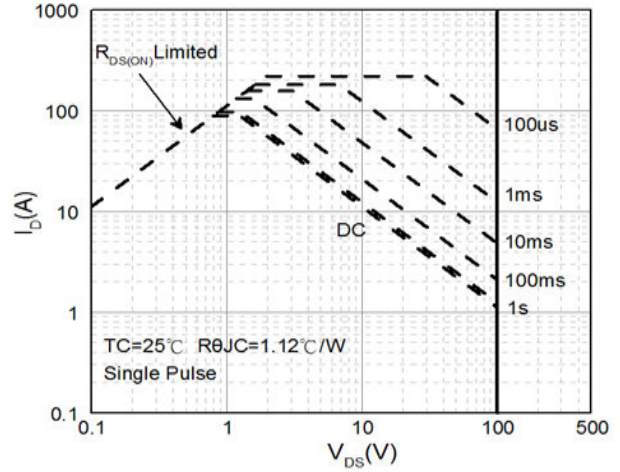

Fig.8 Safe Operating Area

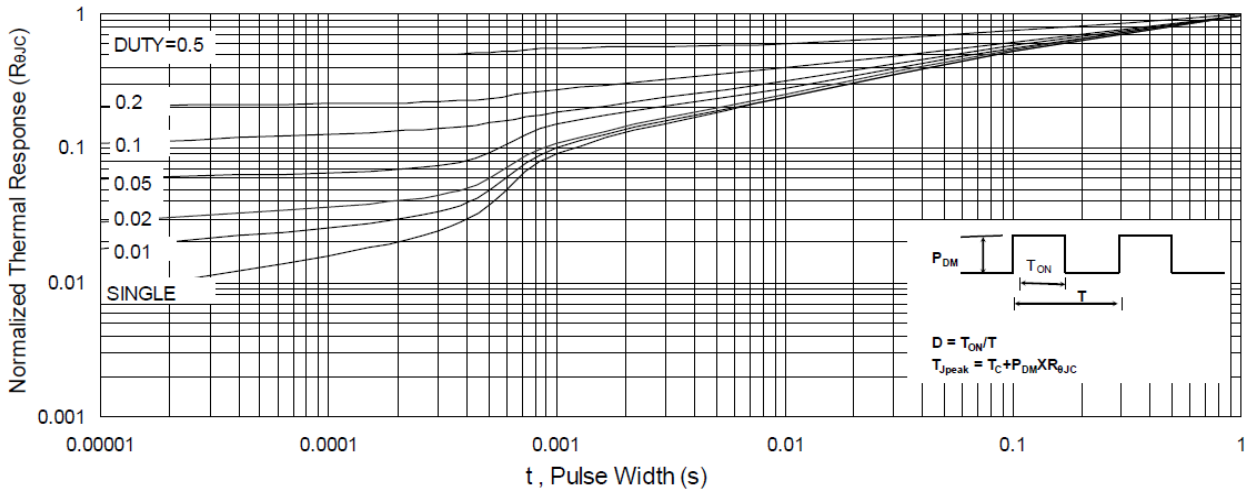

Fig.9 Normalized Maximum Transient Thermal Impedance

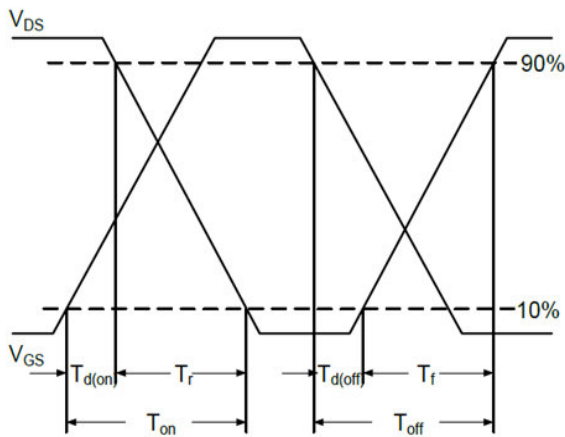

Fig.10 Switching Time Waveform

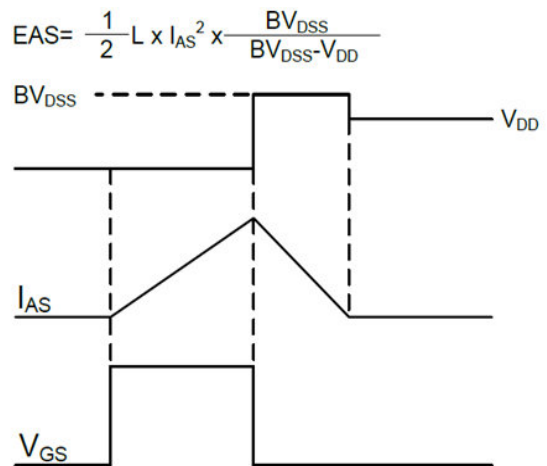

Fig.11 Unclamped Inductive Switching Waveform