

RoHS Compliant Product
A suffix of "-C" specifies halogen & lead-free

FEATURES

- Low Equivalent On-Resistance
- Qualified to AEC-Q101 Standards for High Reliability

MARKING

591

SOT-23

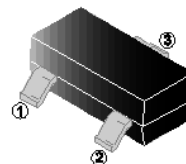

PACKAGE INFORMATION

Package	MPQ	Leader Size
SOT-23	3K	7 inch

ORDER INFORMATION

Part Number	Type
MMBT591CR-C	Lead (Pb)-free and Halogen-free

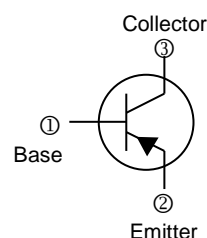

MAXIMUM RATINGS (T_A=25°C unless otherwise specified)

Parameter	Symbol	Ratings	Unit
Collector-Base Voltage	V _{CBO}	-80	V
Collector-Emitter Voltage	V _{CEO}	-60	V
Emitter-Base Voltage	V _{EBO}	-5	V
Collector Current-Continuous	I _C	-1	A
Peak Pulse Current	I _{CM}	-2	A
Collector Power Dissipation	P _C	250	mW
Thermal Resistance from Junction-Ambient	R _{θJA}	500	°C/W
Operation Junction & Storage Temperature Range	T _J , T _{STG}	150, -55~150	°C

ELECTRICAL CHARACTERISTICS (T_A=25°C unless otherwise specified)

Parameter	Symbol	Min.	Typ.	Max.	Unit	Test Conditions
Collector-Base Breakdown Voltage	V _{(BR)CBO}	-80	-	-	V	I _C = -100μA, I _E =0
Collector-Emitter Breakdown Voltage ¹	V _{(BR)CEO}	-60	-	-	V	I _C = -10mA, I _B =0
Emitter-Base Breakdown Voltage	V _{(BR)EBO}	-5	-	-	V	I _E = -100μA, I _C =0
Collector Cut-Off Current	I _{CBO}	-	-	-0.1	μA	V _{CB} = -60V, I _E =0
Emitter Cut-Off Current	I _{EBO}	-	-	-0.1	μA	V _{EB} = -4V, I _C =0
DC Current Gain ¹	h _{FE}	100	-	-	mV	V _{CE} = -5V, I _C = -1mA
		100	-	300		V _{CE} = -5V, I _C = -500mA
		80	-	-		V _{CE} = -5V, I _C = -1A
		15	-	-		V _{CE} = -5V, I _C = -2A
Collector-Emitter Saturation Voltage ¹	V _{CE(sat)}	-	-	-300	mV	I _C = -500mA, I _B = -50mA
		-	-	-600		I _C = -1A, I _B = -100mA
Base-Emitter Saturation Voltage ¹	V _{BE(sat)}	-	-	-1.2	V	I _C = -1A, I _B = -100mA
Base-Emitter Voltage ¹	V _{BE(on)}	-	-	-1	V	V _{CE} = -5V, I _C = -1A
Transition Frequency	f _T	-	150	-	MHz	V _{CE} = -10V, I _C = -50mA, f=100MHz
Collector Output Capacitance	C _{ob}	-	10	-	pF	V _{CB} = -10V, f=1MHz

Note:

1. Measured under pulsed conditions, Pulse width=300μs, Duty cycle≤2%.

CHARACTERISTIC CURVES

Static Characteristic

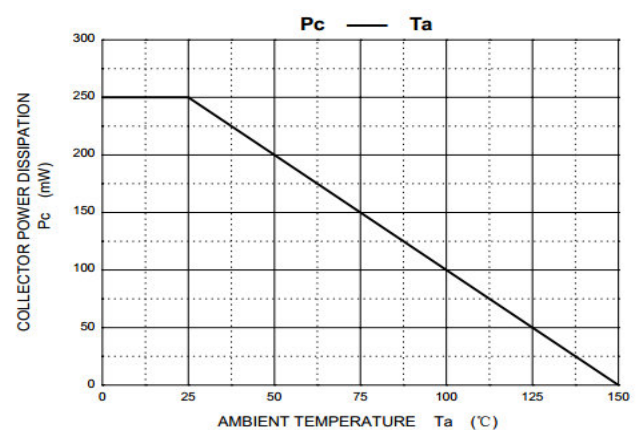
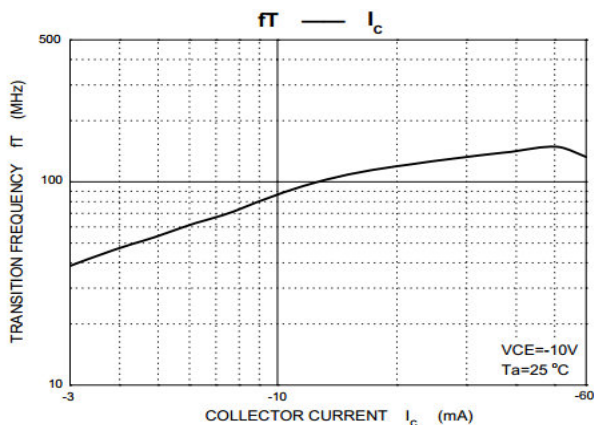
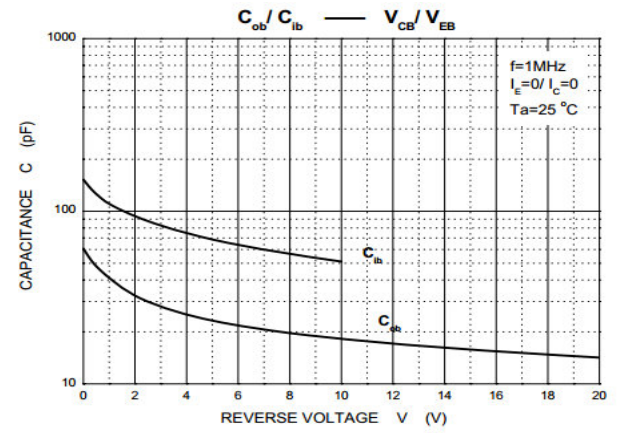
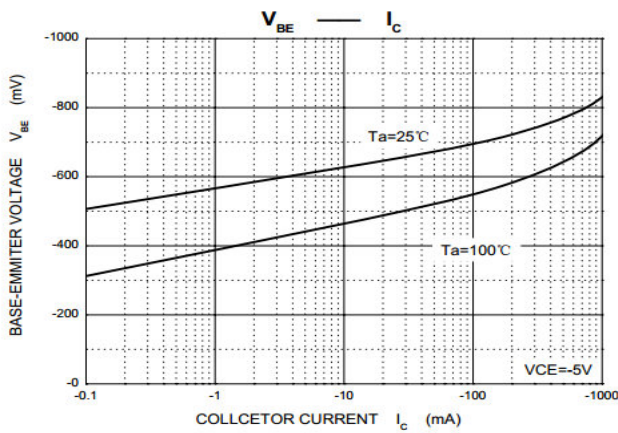
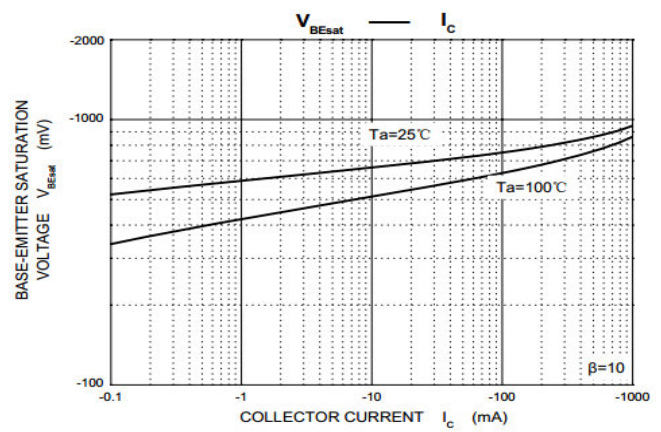
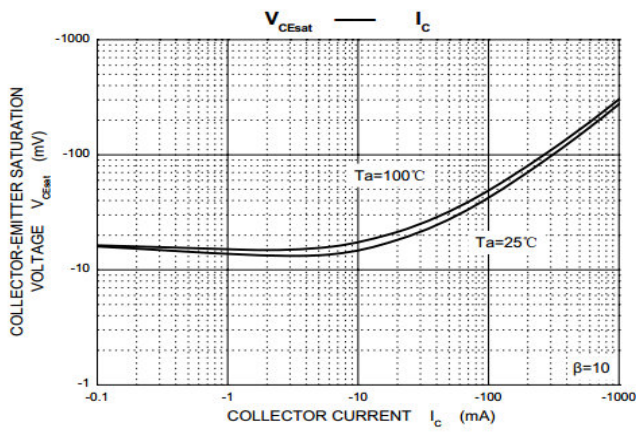
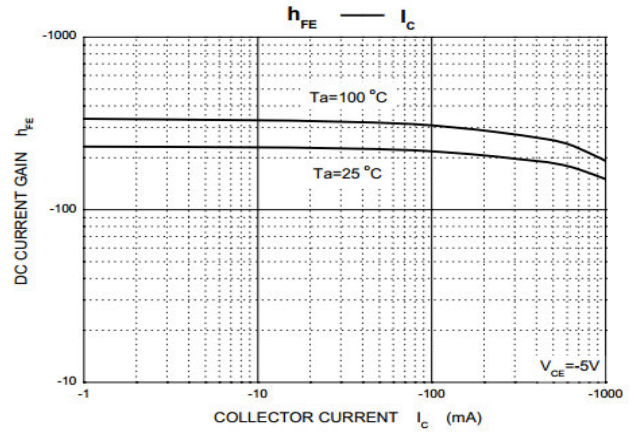
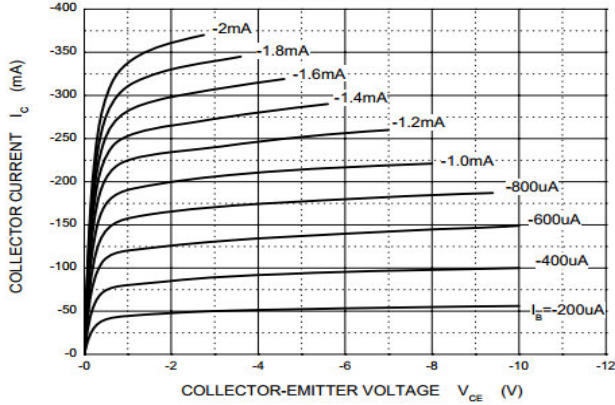

PACKAGE OUTLINE DIMENSIONS

SOT-23

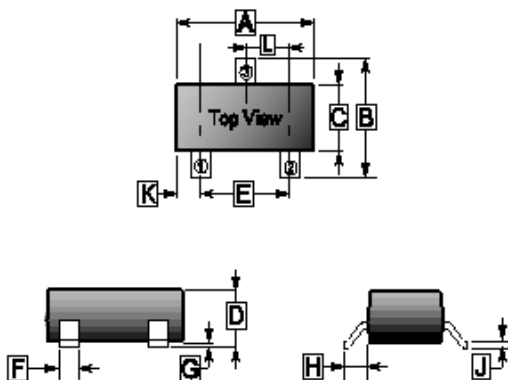

REF.	Millimeter	
	Min.	Max.
A	2.65	3.10
B	2.10	3.00
C	1.10	1.80
D	0.89	1.40
E	1.70	2.30
F	0.28	0.55
G	0	0.18
H	0.55 REF.	
J	0.05	0.26
K	0.60 REF.	
L	0.95 TYP.	

MOUNTING PAD LAYOUT

SOT-23

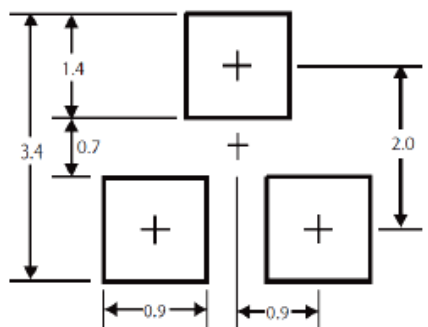

*Dimensions in millimeters