

RoHS Compliant Product  
A suffix of "-C" specifies halogen & lead-free

### FEATURES

- Ideal for Medium Power Amplification and Switching
- Complementary to S8050-C

**SOT-23**

### MARKING

2TY

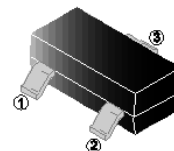

### CLASSIFICATION OF $h_{FE}$

Product-Rank	S8550-L-C	S8550-H-C
Range	120~200	200~350

### PACKAGE INFORMATION

Package	MPQ	Leader Size
SOT-23	3K	7 inch

### ORDER INFORMATION

Part Number	Type
S8550-□-C	Lead (Pb)-free and Halogen-free

\*□= $h_{FE}$  Rank

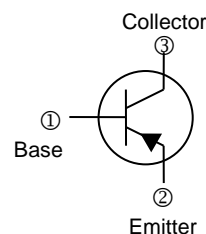

### ABSOLUTE MAXIMUM RATINGS ( $T_A=25^\circ\text{C}$ unless otherwise specified)

Parameter	Symbol	Ratings	Unit
Collector-Base Voltage	$V_{CBO}$	-40	V
Collector-Emitter Voltage	$V_{CEO}$	-25	
Emitter-Base Voltage	$V_{EBO}$	-5	
Collector Current	$I_C$	-0.5	A
Collector Power Dissipation	$P_C$	300	mW
Thermal Resistance from Junction-Ambient	$R_{\theta JA}$	417	$^\circ\text{C/W}$
Junction & Storage Temperature	$T_J, T_{STG}$	150, -55~150	$^\circ\text{C}$

### ELECTRICAL CHARACTERISTICS ( $T_A=25^\circ\text{C}$ unless otherwise specified)

Parameter	Symbol	Min.	Typ.	Max.	Unit	Test Conditions
Collector-Base Breakdown Voltage	$V_{(BR)CBO}$	-40	-	-	V	$I_C = -100\mu\text{A}, I_E = 0$
Collector-Emitter Breakdown Voltage	$V_{(BR)CEO}$	-25	-	-		$I_C = -1\text{mA}, I_B = 0$
Emitter-Base Breakdown Voltage	$V_{(BR)EBO}$	-5	-	-		$I_E = -100\mu\text{A}, I_C = 0$
Collector Cut-off Current	$I_{CBO}$	-	-	-100	nA	$V_{CB} = -40\text{V}, I_E = 0$
Collector Cut-off Current	$I_{CEO}$	-	-	-100		$V_{CE} = -20\text{V}, I_B = 0$
Emitter Cut-off Current	$I_{EBO}$	-	-	-100		$V_{EB} = -3\text{V}, I_C = 0$
DC Current Gain	$h_{FE}$	120	-	350		$V_{CE} = -1\text{V}, I_C = -50\text{mA}$
		50	-	-		$V_{CE} = -1\text{V}, I_C = -500\text{mA}$
Collector-Emitter Saturation Voltage	$V_{CE(sat)}$	-	-	-0.6	V	$I_C = -500\text{mA}, I_B = -50\text{mA}$
Base-Emitter Saturation Voltage	$V_{BE(sat)}$	-	-	-1.2	V	
Transition Frequency	$f_T$	-	150	-	MHz	$V_{CE} = -6\text{V}, I_C = -20\text{mA}, f = 30\text{MHz}$

**CHARACTERISTICS CURVE**

Fig. 1 - Static Characteristics

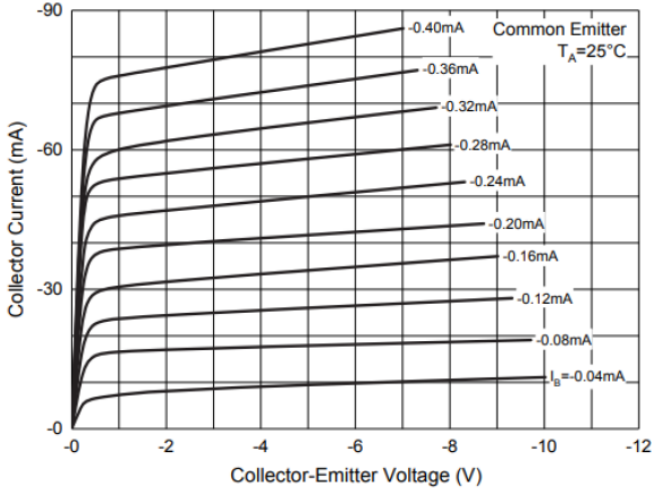

Fig. 2 - DC Current Gain Characteristics

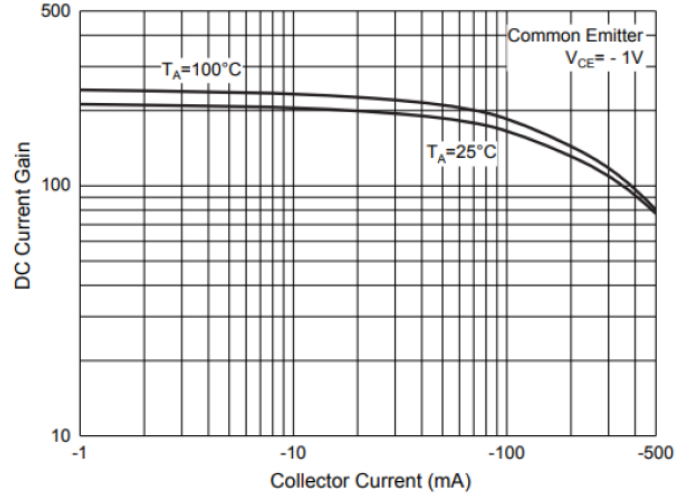

Fig. 3 - Base-Emitter Saturation Voltage Characteristics

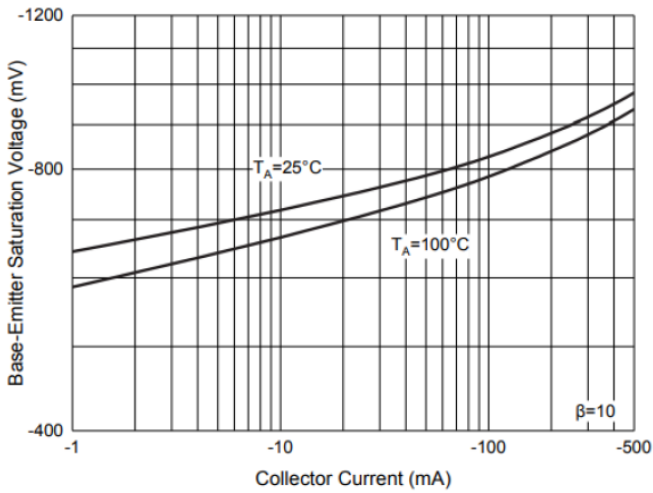

Fig. 4 - Collector-Emitter Saturation Voltage Characteristics

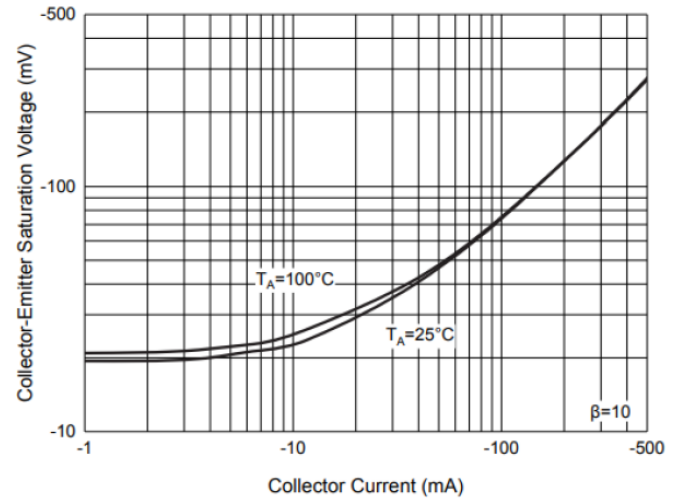

Fig. 5 - Base-Emitter Voltage Characteristics

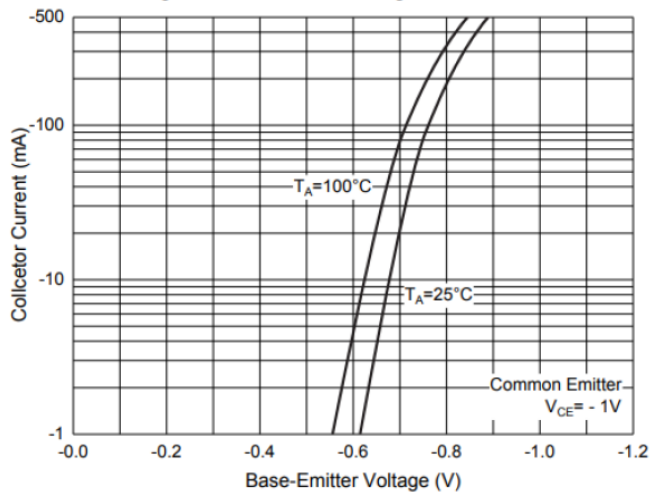
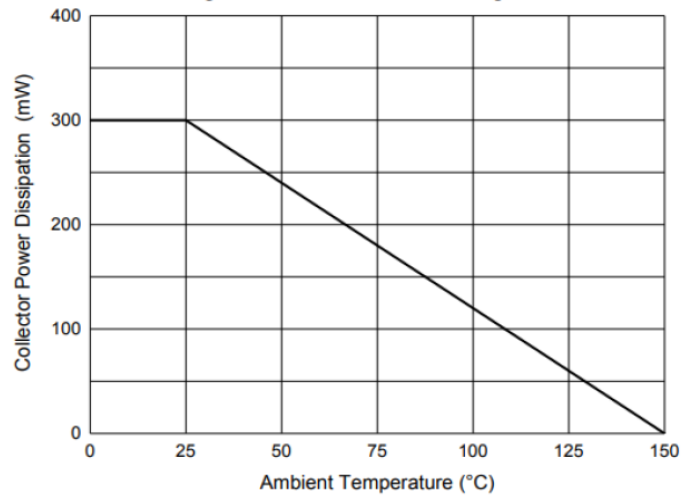
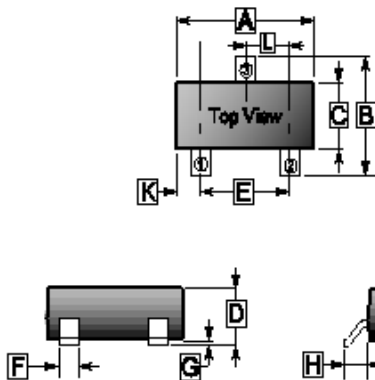

Fig. 6 - Collector Power Derating Curve



**PACKAGE OUTLINE DIMENSIONS**

**SOT-23**



REF.	Millimeter	
	Min.	Max.
A	2.65	3.10
B	2.10	3.00
C	1.10	1.80
D	0.89	1.40
E	1.70	2.30
F	0.28	0.55
G	-	0.18
H	0.55 REF.	
J	0.05	0.26
K	0.60 REF.	
L	0.95 TYP.	

**MOUNTING PAD LAYOUT**

**SOT-23**

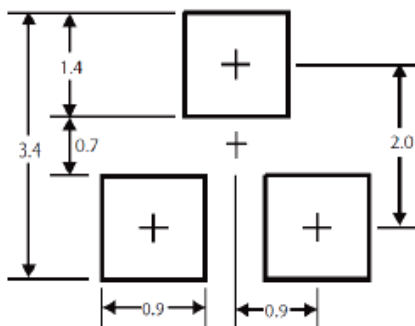

\*Dimensions in millimeters