

RoHS Compliant Product  
A suffix of "-C" specifies halogen-free and RoHS Compliant

## FEATURES

- Heatsink Structure
- Low Profile, Typical Thickness 0.8mm
- Moisture Sensitivity: Level 1, Per J-STD-020
- High Temperature Soldering Guaranteed: 260°C/10 Se cond

## MARKING



↑  
Cathode

## PACKAGE INFORMATION

Package	MPQ	Leader Size
SOD-123DT	3K	7 inch

## ORDER INFORMATION

Part Number	Type
SM120DT-C~SM140DT-C	Lead (Pb)-free and Halogen-free

## SOD-123DT

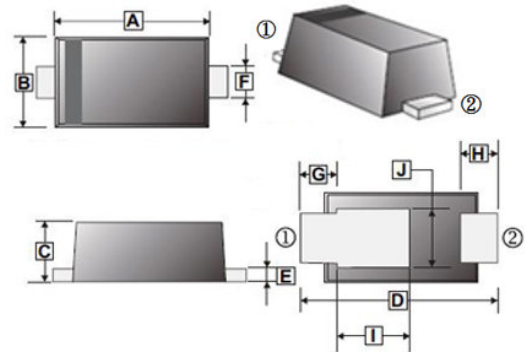

REF.	Millimeter		REF.	Millimeter	
	Min.	Max.		Min.	Max.
A	2.9	3.1	F	0.85	1.05
B	1.9	2.1	G	0.6 REF.	
C	0.75	0.9	H	0.4	0.85
D	3.5	3.9	I	1.66 REF.	
E	0.1	0.25	J	1.3	1.7

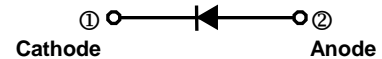

## MAXIMUM RATINGS AND ELECTRICAL CHARACTERISTICS (T<sub>A</sub>=25°C unless otherwise specified)

Parameter	Symbol	Part Number			Unit
		SM120DT-C	SM130DT-C	SM140DT-C	
Maximum Repetitive Peak Reverse Voltage	V <sub>RRM</sub>	20	30	40	V
Maximum RMS Voltage	V <sub>RMS</sub>	14	21	28	
Maximum DC Blocking Voltage	V <sub>DC</sub>	20	30	40	
Minimum Breakdown Voltage @I <sub>R</sub> =1mA	V <sub>BR</sub>	20	30	40	
Maximum Average Forward Rectified Current	I <sub>F</sub>	1			A
Peak Forward Surge Current @8.3ms Single Half Sine-Wave Superimposed on Rate Load	I <sub>FSM</sub>	30			A
Rating for Fusing (t<8.3ms)	I <sup>2</sup> t	4			A <sup>2</sup> S
Maximum Instantaneous Forward Voltage @I <sub>F</sub> =1A	V <sub>F</sub>	T <sub>A</sub> =25°C	0.5		V
		T <sub>A</sub> =75°C	0.5		
Maximum DC Reverse Current At Rated DC Blocking Voltage	I <sub>R</sub>	T <sub>A</sub> =25°C	50		uA
		T <sub>A</sub> =75°C	1		mA
Typical Junction Capacitance @4V, 1MHz	C <sub>J</sub>	51.2			pF
Typical Thermal Resistance from Junction-Ambient <sup>1</sup>	R <sub>θJA</sub>	65			°C/W
Typical Thermal Resistance from Junction-Case <sup>2</sup>	R <sub>θJC</sub>	35			
Typical Thermal Resistance from Junction-Lead <sup>1</sup>	R <sub>θJL</sub>	9			
Operating Junction and Storage Temperature	T <sub>J</sub> , T <sub>STG</sub>	-55~150			°C

Notes:

1. The thermal resistance from junction to ambient or lead, mounted on P.C.B with 5x5mm copper pads, 2 OZ, FR4 PCB.
2. The thermal resistance from junction to case, mounted on P.C.B with recommended copper pads, 2 OZ, FR4 PCB.

**CHARACTERISTIC CURVES**

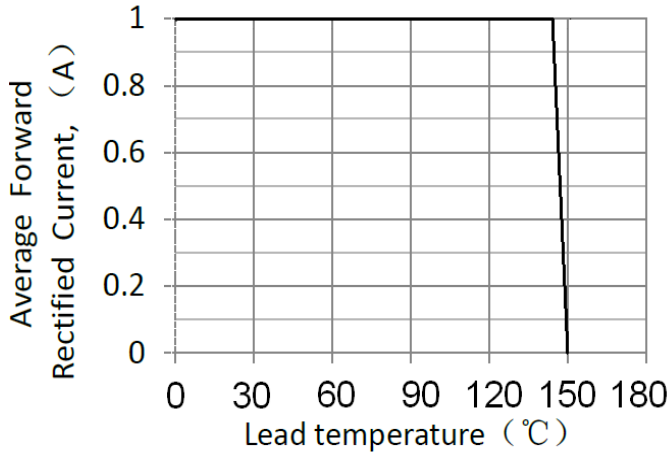

Figure 1. Forward Current Derating Curve

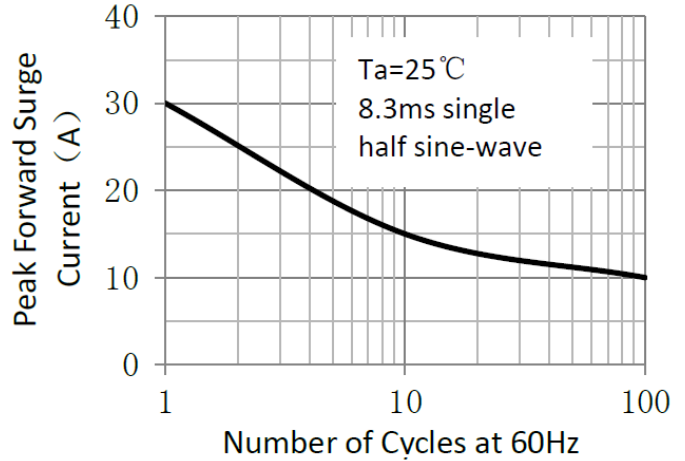

Figure 2. Maximum Non-Repetitive Peak Forward Surge Current

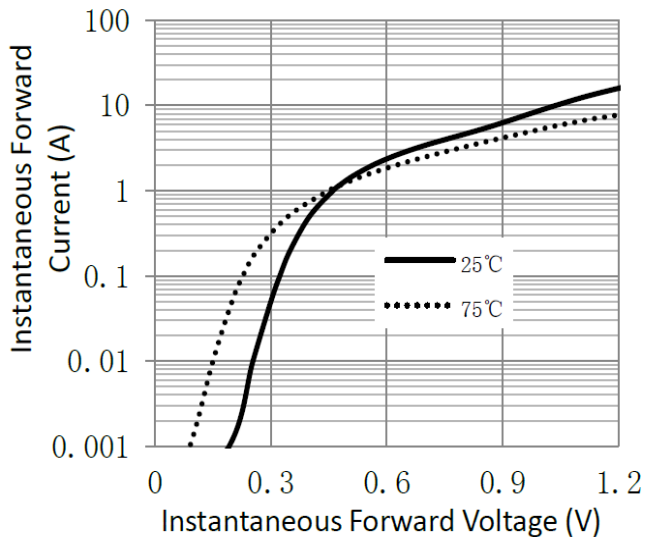

Figure 3. Typical Instantaneous Forward Characteristics

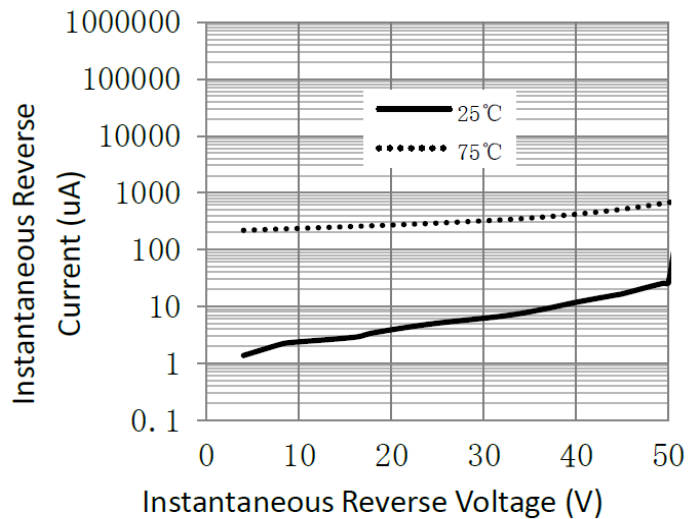

Figure 4. Typical Reverse Characteristics

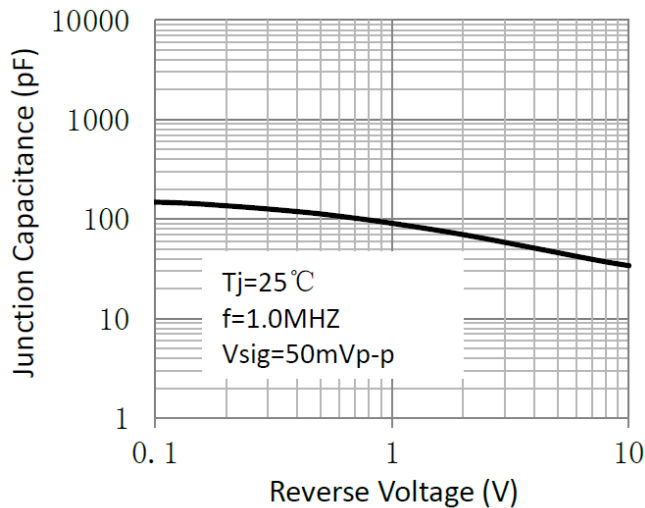
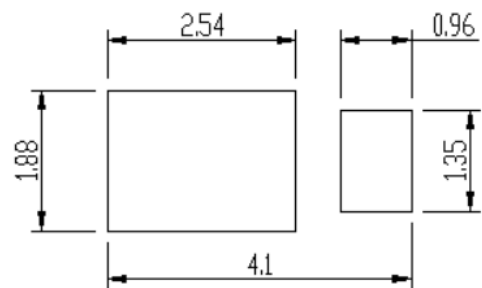

Figure 5. Typical Junction Capacitance



\*Dimensions in millimeters

Figure 6. Mounting Pad Layout