

RoHS Compliant Product
A suffix of "-C" specifies halogen & lead-free

FEATURES

- Plastic Package has Underwriters Laboratory Flammability Classification 94V-0
Flame Retardant Epoxy Molding Compound
- Metal Silicon Junction, Majority Carrier Conduction
- Low Power Loss, High Efficiency
- High Current Capability
- For use in Low Voltage High Frequency Inverters, Free Wheeling, and Polarity Protection Applications

MECHANICAL DATA

- Case: TO-263(D²-Pack) Molded Plastic
- Terminals: Solder Plated, Solderable Per MIL-STD-750, Method 2026
- Polarity: As marked
- Mounting Position: Any

PACKAGE INFORMATION

Package	MPQ	Leader Size
TO-263	0.8K	13 inch

ORDER INFORMATION

Part Number	Type
MBR3040D~MBR30200D	Lead (Pb)-free
MBR3040D-C~MBR30200D-C	Lead (Pb)-free and Halogen-free

TO-263(D²-PACK)

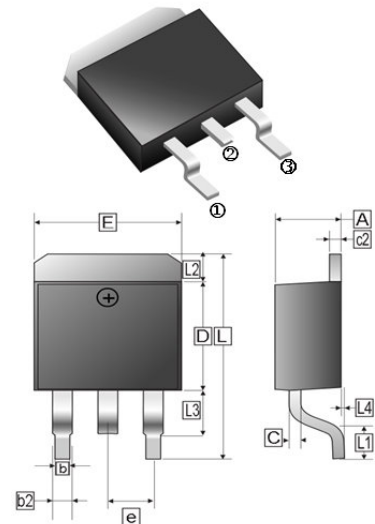

REF.	Millimeter		REF.	Millimeter	
	Min.	Max.		Min.	Max.
A	4.00	4.87	c2	1.07	1.65
b	0.51	1.01	b2	1.34 REF	
L4	0.00	0.30	D	8.0	9.65
C	0.30	0.74	e	2.54 REF	
L3	1.50 REF		L	14.6	16.1
L1	2.5 REF		L2	1.27 REF	
E	9.60	10.67			

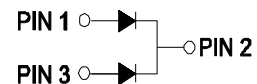

MAXIMUM RATINGS AND ELECTRICAL CHARACTERISTICS

(Rating 25°C ambient temperature unless otherwise specified. Single phase half wave, 60Hz, resistive or inductive load.
For capacitive load, de-rate current by 20%.)

Parameter	Symbol	Part Number					Unit
		MBR 3040D	MBR 3060D	MBR 30100D	MBR 30150D	MBR 30200D	
Maximum Recurrent Peak Reverse Voltage	V_{RRM}	40	60	100	150	200	V
Maximum RMS Voltage	V_{RMS}	28	42	70	105	140	
Maximum DC Blocking Voltage	V_{DC}	40	60	100	150	200	
Maximum Average Forward Current	$I_{F(AV)}$	30					A
Peak Forward Surge Current, 8.3ms single half sine-wave superimposed on rated load(JEDEC Method)	I_{FSM}	250					A
Maximum Forward Voltage @15A Per Leg	V_F	0.7	0.8	0.85	0.92		V
Maximum DC Reverse Current @Rated DC Blocking Voltage	$T_J=25^\circ C$	0.05					mA
	$T_J=125^\circ C$	20					
Typical Thermal Resistance	$R_{\theta JC}$	4					°C/W
Operating & Storage Temperature	T_J, T_{STG}	-55~150					°C

RATINGS AND CHARACTERISTIC CURVES

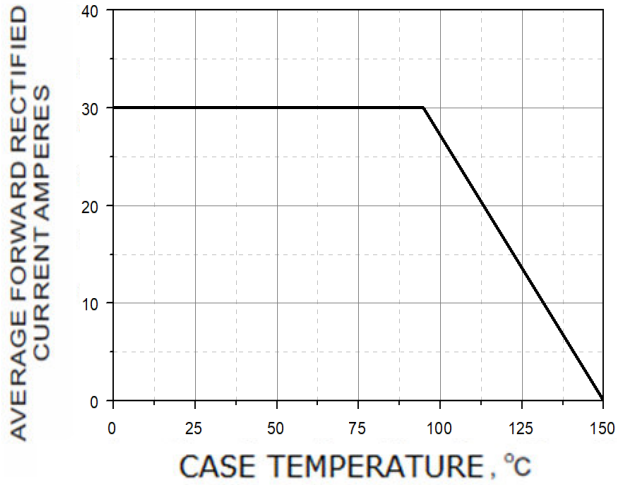

Fig.1- FORWARD CURRENT DERATING CURVE

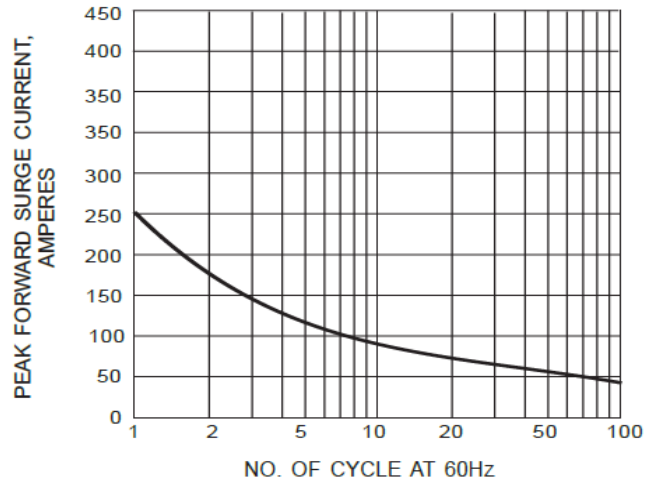

Fig.2- MAXIMUM NON-REPETITIVE SURGE CURRENT

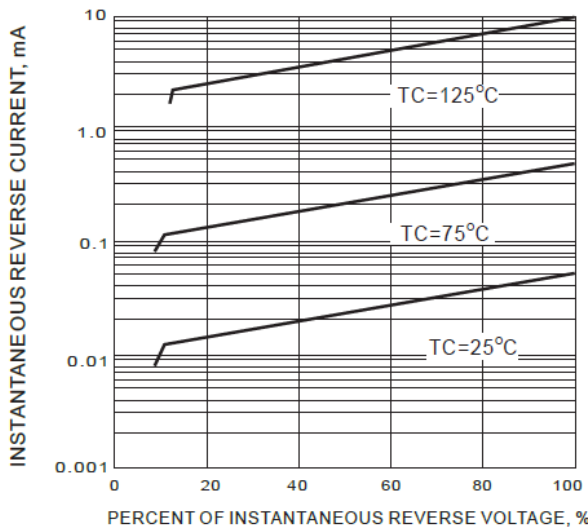

Fig.3- TYPICAL REVERSE CHARACTERISTIC

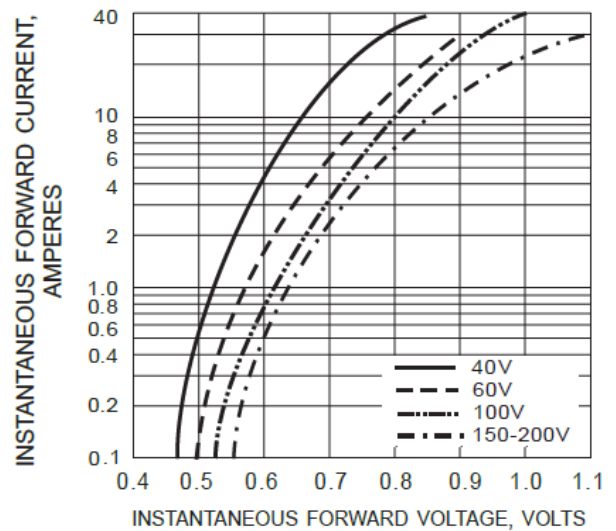
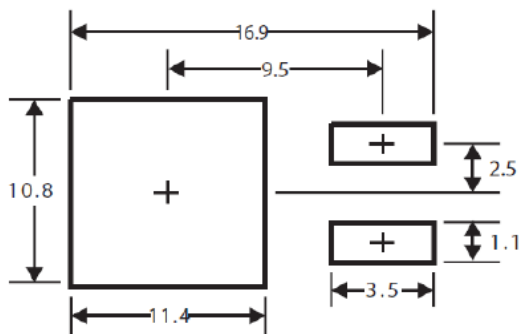

Fig.4- TYPICAL INSTANTANEOUS FORWARD CHARACTERISTIC



*Dimensions in millimeters

Fig.5- MOUNTING PAD LAYOUT