

RoHS Compliant Product
A suffix of "-C" specifies halogen & lead-free

DESCRIPTION

The SPR86N03S-C is the Shielded Gate Technology N-ch MOSFETs with extreme high cell density, which provide excellent $R_{DS(ON)}$ and gate charge for most of the synchronous buck converter applications.

The SPR86N03S-C meet the RoHS and Green Product requirement with full function reliability approved.

FEATURES

- Shielded Gate Trench Technology
- Super Low Gate Charge
- Green Device Available

MARKING

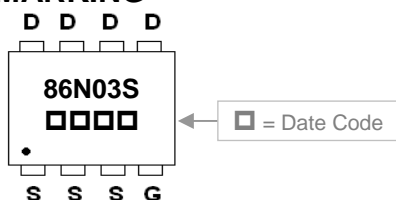

PACKAGE INFORMATION

Package	MPQ	Leader Size
PR-8PP	3K	13 inch

ORDER INFORMATION

Part Number	Type
SPR86N03S-C	Lead (Pb)-free and Halogen-free

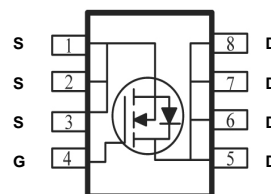

Mounting Pad Layout

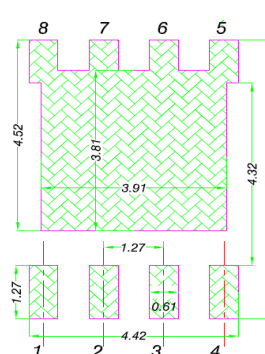

REF.	Millimeter		REF.	Millimeter	
	Min.	Max.		Min.	Max.
A	4.90	5.10	G	0.80	1.00
B	5.70	5.90	H	0.254 REF.	
C	5.95	6.20	I	4.00 REF.	
D	1.27 BSC.		J	3.40 REF.	
E	0.35	0.49	K	0.60 REF.	
F	0.10	0.20	L	1.40 REF.	

ABSOLUTE MAXIMUM RATINGS ($T_J=25^\circ\text{C}$ unless otherwise specified)

Parameter	Symbol	Ratings	Unit	
Drain-Source Voltage	V_{DS}	30	V	
Gate-Source Voltage	V_{GS}	± 20	V	
Continuous Drain Current ¹ @ $V_{GS}=10\text{V}$	$T_C=25^\circ\text{C}$	86	A	
	$T_C=100^\circ\text{C}$	50		
Pulsed Drain Current ³	I_{DM}	200	A	
Power Dissipation ^{1 2}	$T_C=25^\circ\text{C}$	P_D	44.6	W
Operating Junction & Storage Temperature Range		T_J, T_{STG}	-55~150	$^\circ\text{C}$
Thermal Resistance Ratings				
Maximum Thermal Resistance Junction-Ambient ¹	$R_{\theta JA}$	62	$^\circ\text{C/W}$	
Maximum Thermal Resistance Junction-Case ¹	$R_{\theta JC}$	2.8		

ELECTRICAL CHARACTERISTICS ($T_J=25^\circ C$ unless otherwise specified)

Parameter	Symbol	Min.	Typ.	Max.	Unit	Test Conditions	
Drain-Source Breakdown Voltage	$V_{(BR)DSS}$	30	-	-	V	$V_{GS}=0V, I_D=250\mu A$	
Gate-Threshold Voltage	$V_{GS(th)}$	1	-	2.5	V	$V_{DS}=V_{GS}, I_D=250\mu A$	
Gate-Source Leakage Current	I_{GSS}	-	-	± 100	nA	$V_{GS}=\pm 20V$	
Drain-Source Leakage Current	I_{DSS}	$T_J=25^\circ C$	-	-	1	uA	$V_{DS}=24V, V_{GS}=0V$
		$T_J=55^\circ C$	-	-	5		
Static Drain-Source On-Resistance ³	$R_{DS(ON)}$	-	3.2	3.9	m Ω	$V_{GS}=10V, I_D=15A$	
		-	4.9	6.2		$V_{GS}=4.5V, I_D=10A$	
Total Gate Charge	Q_g	-	14.7	-	nC	$I_D=15A$ $V_{BS}=15V$ $V_{GS}=4.5V$	
Gate-Source Charge	Q_{gs}	-	5.8	-			
Gate-Drain Charge	Q_{gd}	-	3.5	-			
Turn-on Delay Time	$T_{d(on)}$	-	7.5	-	nS	$V_{DD}=15V$ $I_D=15A$ $V_{GS}=10V$ $R_G=3\Omega$	
Rise Time	T_r	-	20.2	-			
Turn-off Delay Time	$T_{d(off)}$	-	21.6	-			
Fall Time	T_f	-	4.4	-			
Input Capacitance	C_{iss}	-	1476	-	pF	$V_{GS}=0V$ $V_{DS}=15V$ $f=1MHz$	
Output Capacitance	C_{oss}	-	556	-			
Reverse Transfer Capacitance	C_{rss}	-	70	-			
Source-Drain Diode							
Diode Forward Voltage ³	V_{SD}	-	-	1.2	V	$I_S=1A, V_{GS}=0V$	
Continuous Source Current ¹	I_S	-	-	86	A		
Pulsed Source Current ³	I_{SM}	-	-	200	A		

Notes:

1. The data tested by surface mounted on a 1 inch² FR-4 board with 2oz copper.
2. The power dissipation is limited by 150 $^\circ C$ junction temperature.
3. The Pulse Test: Pulse Width $\leq 300\mu s$, Duty Cycle $\leq 2\%$.

CHARACTERISTIC CURVES

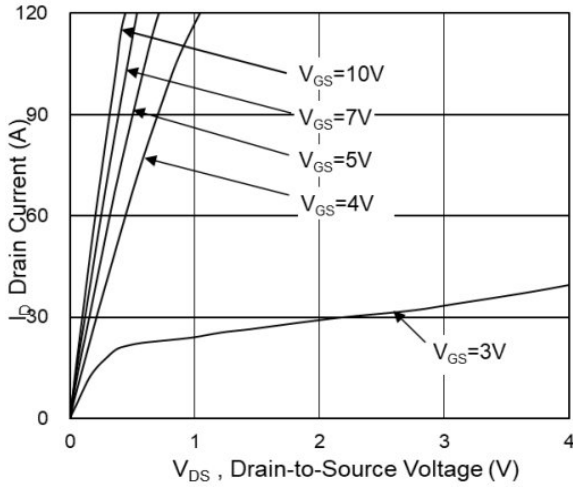

Fig.1 Typical Output Characteristics

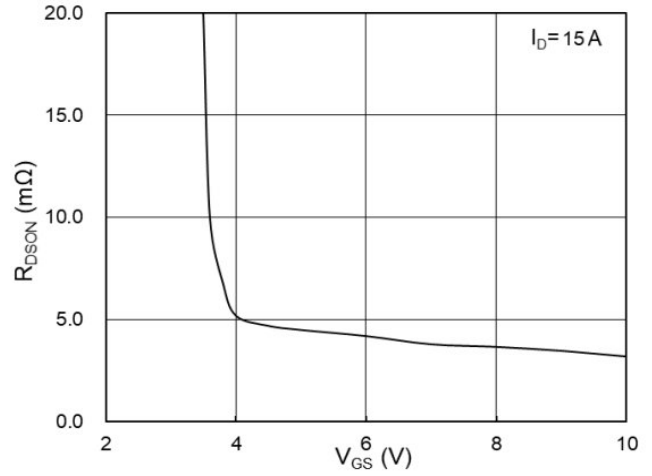

Fig.2 On-Resistance vs G-S Voltage

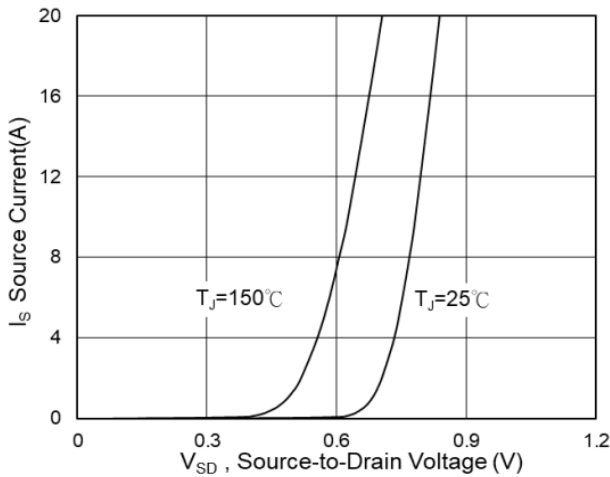

Fig.3 Source Drain Forward Characteristics

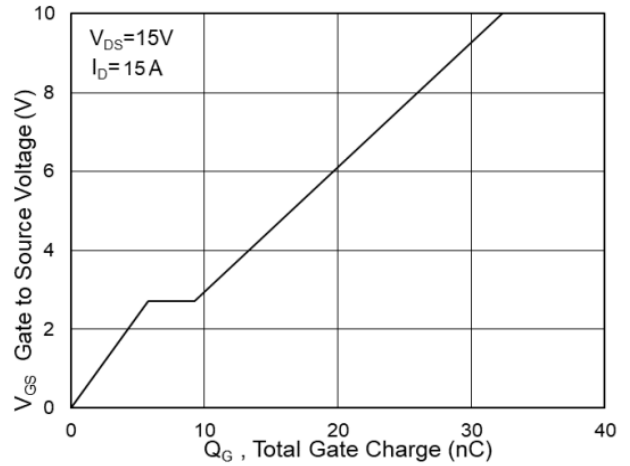

Fig.4 Gate-Charge Characteristics

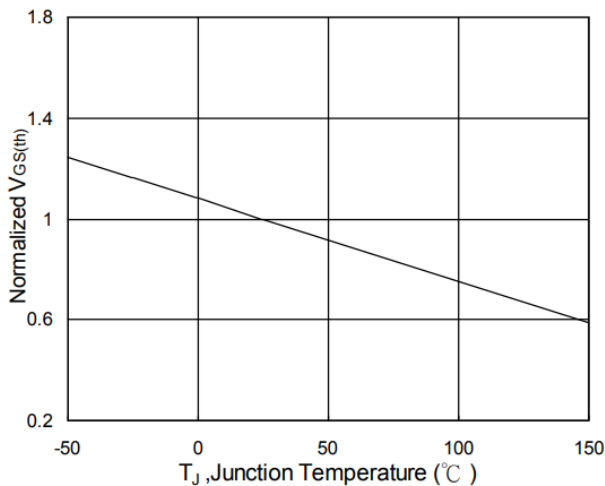

Fig.5 Normalized $V_{GS(th)}$ vs T_J

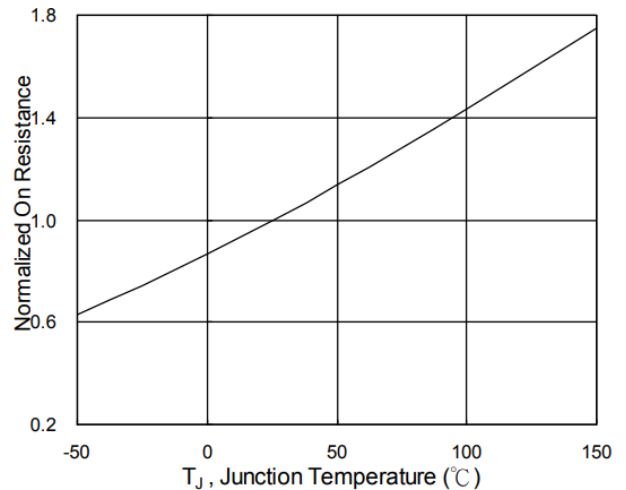

Fig.6 Normalized $R_{DS(on)}$ vs T_J

CHARACTERISTIC CURVES

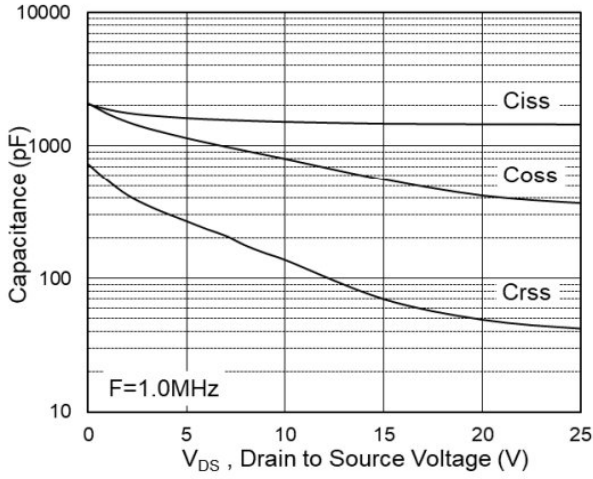

Fig.7 Capacitance

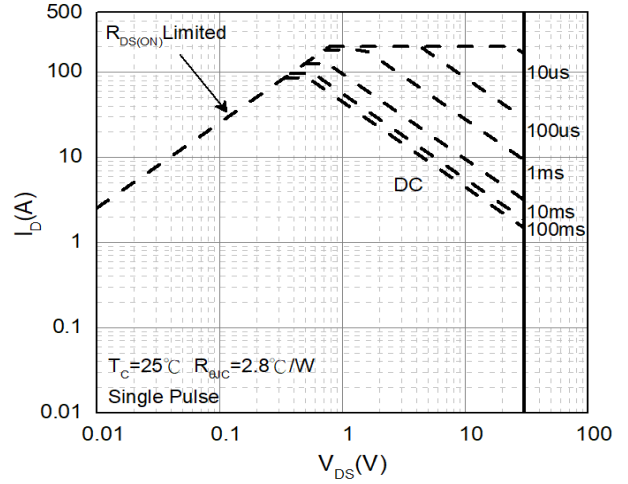

Fig.8 Safe Operating Area

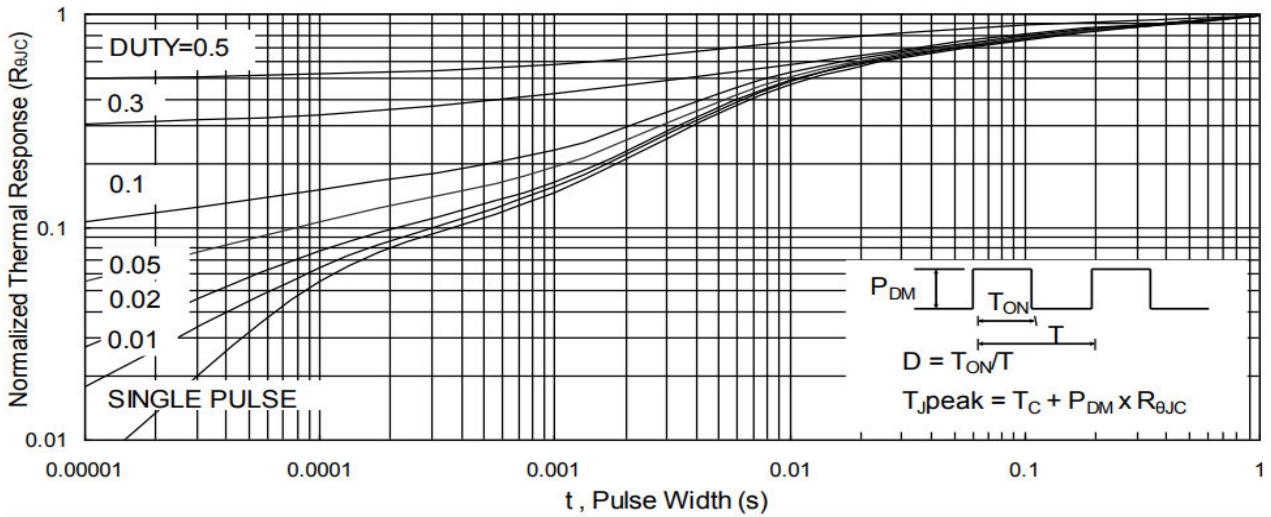

Fig.9 Normalized Maximum Transient Thermal Impedance

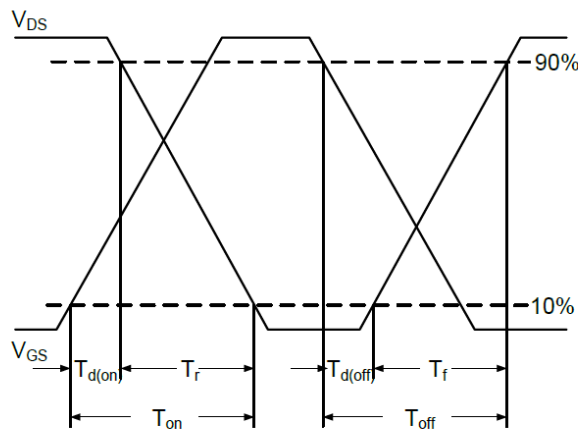

Fig.10 Switching Time Waveform

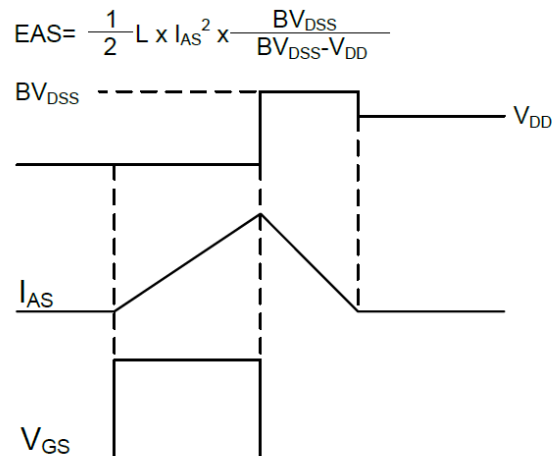

Fig.11 Unclamped Inductive Waveform