

RoHS Compliant Product
A suffix of "-C" specifies halogen & lead-free

DESCRIPTION

The SMS3401A-C provide the designer with the best combination of fast switching, ruggedized device design, low on-resistance and cost-effectiveness. The SOT-23 package is universally preferred for all commercial-industrial surface mount applications and suited for low voltage applications such as DC/DC converters.

SOT-23

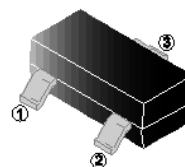

FEATURES

- Lower Gate Charge
- Simple Drive Requirement
- Fast Switching Characteristic

MARKING

R1_A

PACKAGE INFORMATION

Package	MPQ	Leader Size
SOT-23	3K	7 inch

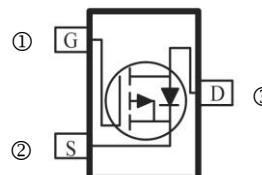

ORDER INFORMATION

Part Number	Type
SMS3401A-C	Lead (Pb)-free and Halogen-free

ABSOLUTE MAXIMUM RATINGS (T_A=25°C unless otherwise specified)

Parameter	Symbol	Rating	Unit
Drain-Source Voltage	V _{DS}	-30	V
Gate-Source Voltage	V _{GS}	±12	V
Continuous Drain Current ²	I _D	-4.2	A
Maximum Power Dissipation ¹	P _D	400	mW
Thermal Resistance Junction-Ambient ²	R _{θJA}	313	°C/W
Operating Junction & Storage Temperature Range	T _J , T _{STG}	150, -55~150	°C

ELECTRICAL CHARACTERISTICS ($T_A=25^\circ\text{C}$ unless otherwise specified)

Parameter	Symbol	Min.	Typ.	Max.	Unit	Test Conditions
Drain-Source Breakdown Voltage	$V_{(BR)DSS}$	-30	-	-	V	$V_{GS}=0, I_D = -250\mu\text{A}$
Gate-Threshold Voltage ³	$V_{GS(th)}$	-0.7	-	-1.3	V	$V_{DS}=V_{GS}, I_D = -250\mu\text{A}$
Forward Transconductance ³	g_{fs}	7	-	-	S	$V_{DS} = -5\text{V}, I_D = -5\text{A}$
Gate-Source Leakage Current	I_{GSS}	-	-	± 100	nA	$V_{GS} = \pm 12\text{V}, V_{DS}=0$
Drain-Source Leakage Current	I_{DSS}	-	-	-1	μA	$V_{DS} = -24\text{V}, V_{GS}=0$
Static Drain-Source On-Resistance ³	$R_{DS(ON)}$	-	-	60	m Ω	$V_{GS} = -10\text{V}, I_D = -4.2\text{A}$
		-	-	70		$V_{GS} = -4.5\text{V}, I_D = -4\text{A}$
		-	-	85		$V_{GS} = -2.5\text{V}, I_D = -1\text{A}$
Total Gate Charge	Q_g	-	9.5	-	nC	$I_D = -4\text{A}, V_{DS} = -15\text{V}, V_{GS} = -4.5\text{V}$
Turn-on Delay Time	$T_{d(on)}$	-	6.5	-	nS	$V_{GS} = -10\text{V}$ $V_{DS} = -15\text{V}$ $R_{GEN}=6\Omega$ $R_L=3.6\Omega$
Rise Time	T_r	-	3.5	-		
Turn-off Delay Time	$T_{d(off)}$	-	40	-		
Fall Time	T_f	-	13	-		
Input Capacitance	C_{iss}	-	1050	-	pF	$V_{GS}=0$ $V_{DS} = -15\text{V}$ $f=1\text{MHz}$
Output Capacitance	C_{oss}	-	127	-		
Reverse Transfer Capacitance	C_{rss}	-	85	-		
Source-Drain Diode						
Forward Voltage ³	V_{SD}	-	-	-1	V	$V_{GS}=0, I_S = -1\text{A}$

Notes:

1. Pulse width limited by maximum junction temperature.
2. Surface Mounted on FR-4 Board, When Mounted on 1 inch² FR-4 Board, $t < 5\text{sec}$, $R_{\theta JA} = 100^\circ\text{C/W}$.
3. Pulse Width $\leq 300\mu\text{s}$, Duty Cycle $\leq 2\%$.

CHARACTERISTIC CURVES

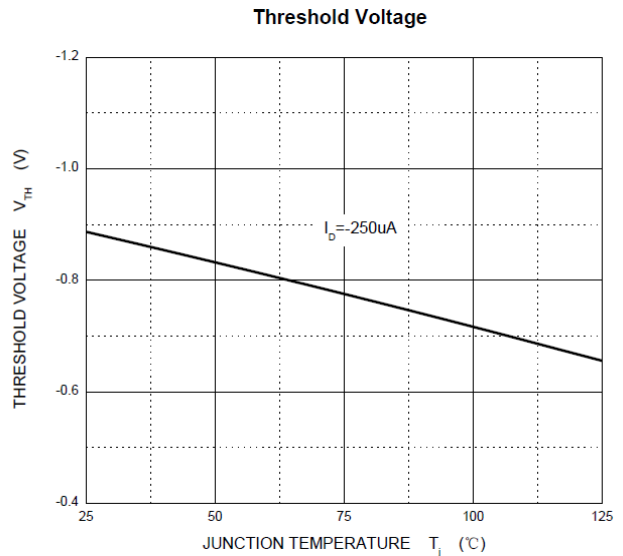
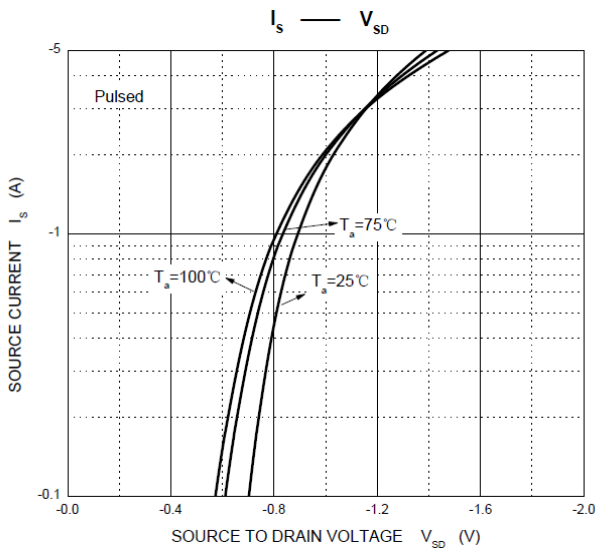
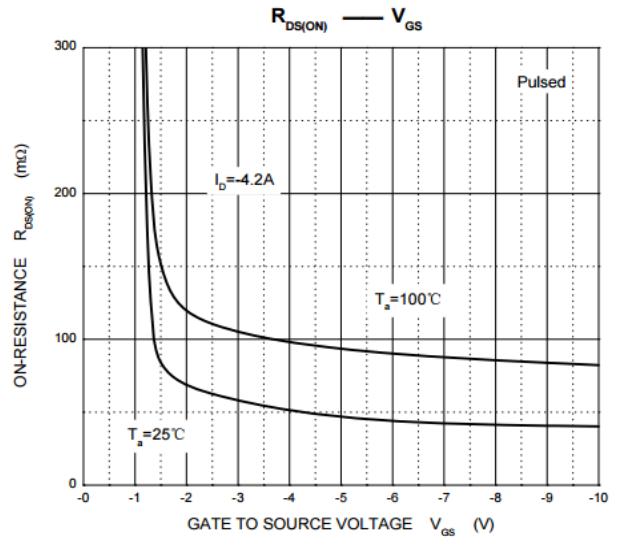
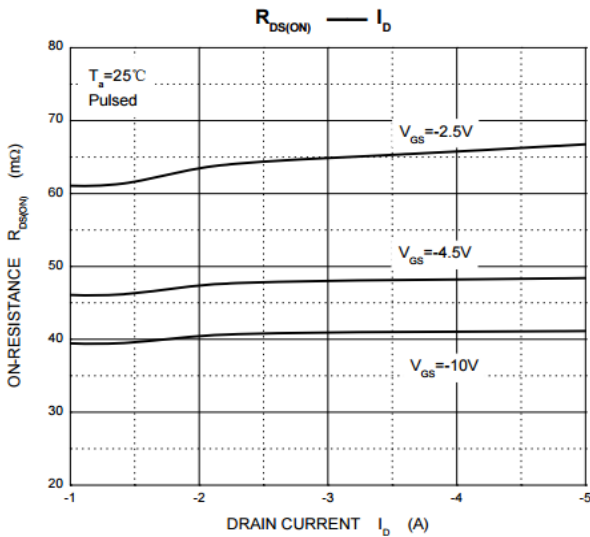
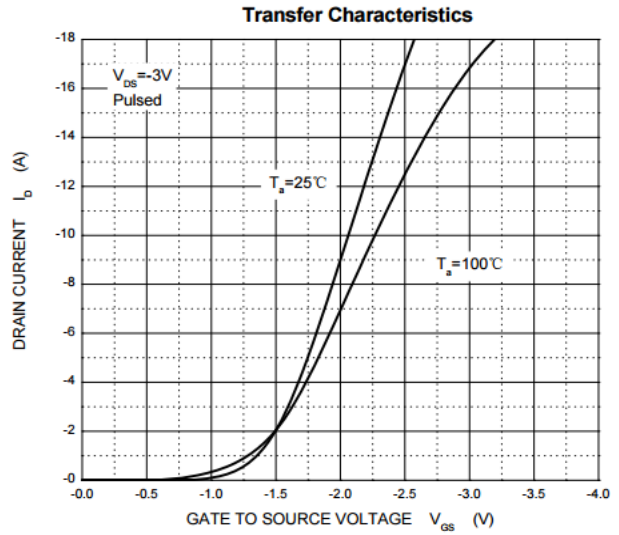
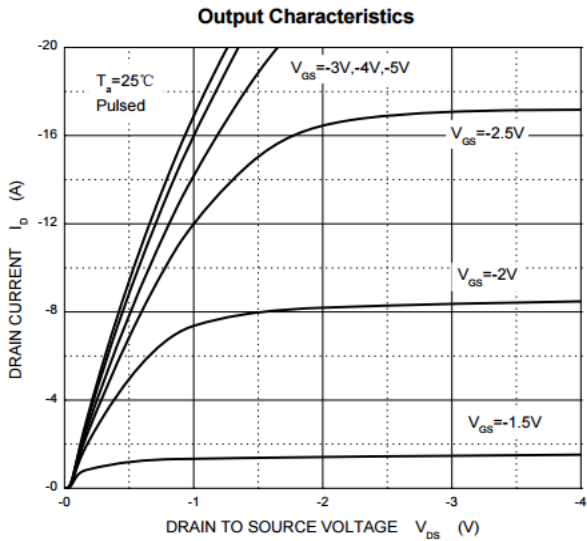

CHARACTERISTIC CURVES

Typical Capacitance Characteristics

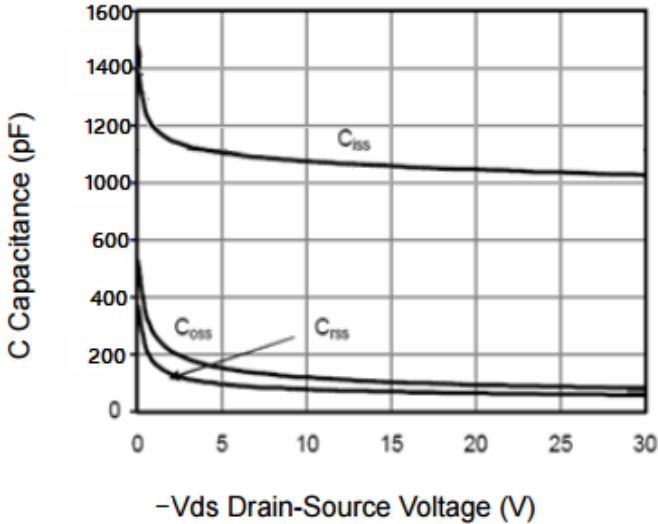

Gate Charge Characteristics

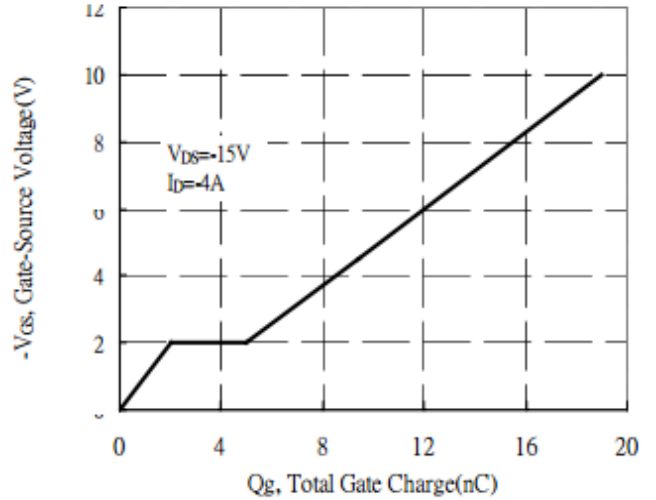

Drain-Source On-Resistance

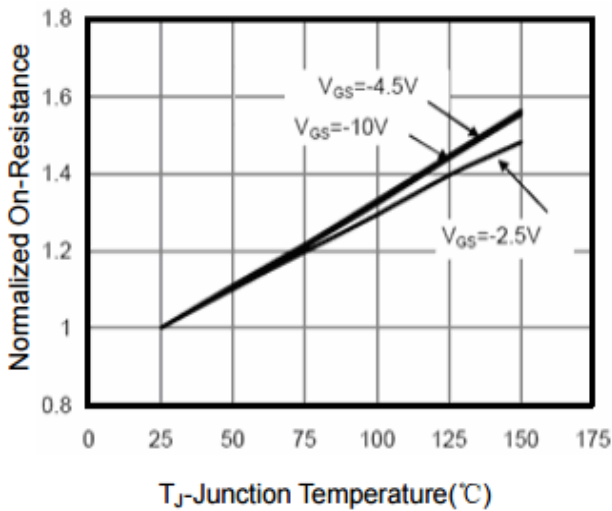

Safe Operation Area

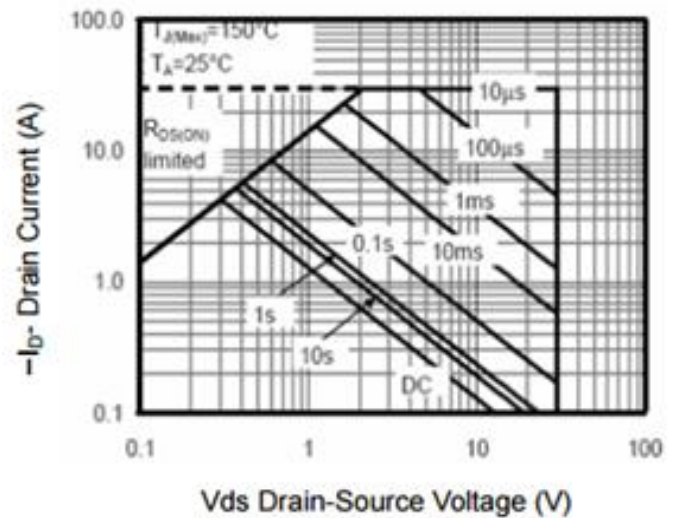

Normalized Maximum Transient Thermal Impedance

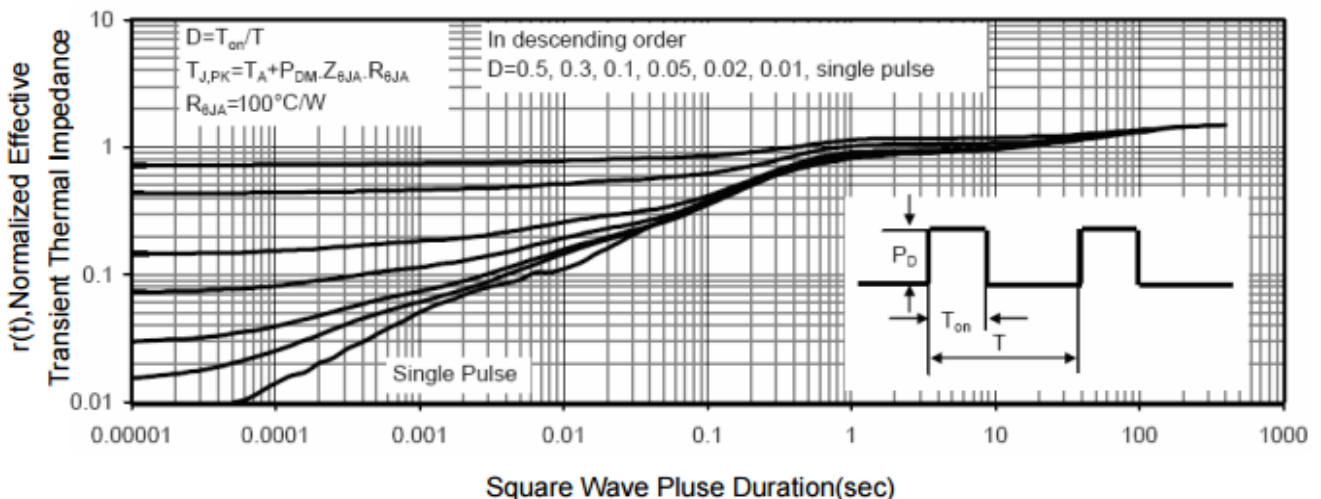

PACKAGE OUTLINE DIMENSIONS

SOT-23

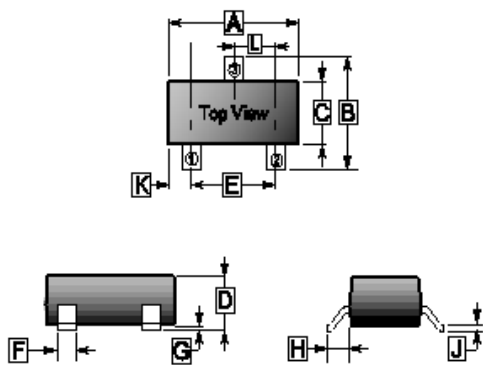

REF.	Millimeter	
	Min.	Max.
A	2.65	3.10
B	2.10	3.00
C	1.10	1.80
D	0.89	1.40
E	1.70	2.30
F	0.28	0.55
G	0	0.18
H	0.55 REF.	
J	0.05	0.26
K	0.60 REF.	
L	0.95 TYP.	

MOUNTING PAD LAYOUT

SOT-23

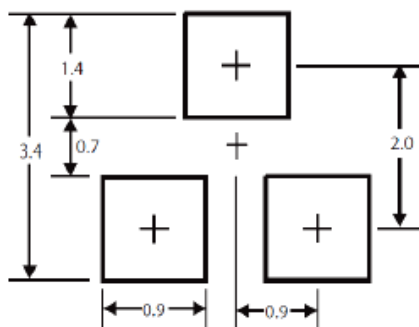

*Dimensions in millimeters