

RoHS Compliant Product
A suffix of "-C" specifies halogen and lead-free

DESCRIPTION

SST2605 utilized advanced processing techniques to achieve the lowest possible on-resistance, extremely efficient and cost-effectiveness device. The SOT-26 package is universally used for all commercial-industrial applications.

FEATURES

- Simple Drive Requirement
- Smaller Outline Package
- Surface mount package

MARKING

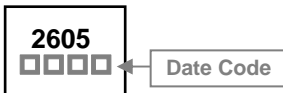

SOT-26

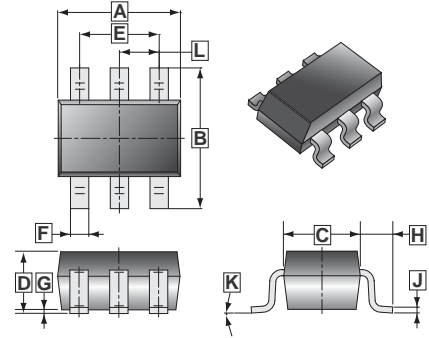

REF.	Millimeter		REF.	Millimeter	
	Min.	Max.		Min.	Max.
A	2.70	3.10	G	0	0.10
B	2.60	3.00	H	0.60	REF.
C	1.40	1.80	J	0.12	REF.
D	1.30	MAX.	K	0°	10°
E	1.90	REF.	L	0.95	REF.
F	0.30	0.50			

PACKAGE INFORMATION

Package	MPQ	Leader Size
SOT-26	3K	7 inch

TOP VIEW

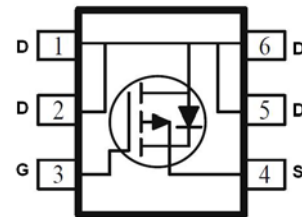

ABSOLUTE MAXIMUM RATINGS ($T_A=25^\circ\text{C}$ unless otherwise specified)

Parameter	Symbol	Ratings	Unit
Drain-Source Voltage	V_{DS}	-30	V
Gate-Source Voltage	V_{GS}	± 20	V
Continuous Drain Current ³	I_D	$T_A=25^\circ\text{C}$	-4
		$T_A=70^\circ\text{C}$	-3.3
Pulsed Drain Current ¹	I_{DM}	-20	A
Power Dissipation	P_D	2	W
Linear Derating Factor		0.016	W / $^\circ\text{C}$
Operating Junction and Storage Temperature Range	T_j, T_{stg}	-55~150	$^\circ\text{C}$
Thermal Resistance Rating			
Maximum Junction to Ambient ³	$R_{\theta JA}$	62.5	$^\circ\text{C} / \text{W}$

ELECTRICAL CHARACTERISTICS ($T_J=25^\circ\text{C}$ unless otherwise specified)

Parameter	Symbol	Min.	Typ.	Max.	Unit	Test Conditions
Static						
Drain-Source Breakdown Voltage	BV_{DSS}	-30	-	-	V	$V_{GS}=0, I_D = -250\mu\text{A}$
	$BV_{DS} / \Delta T_J$	-	-0.02	-	V/ $^\circ\text{C}$	Reference to 25°C , $I_D = -1\text{mA}$
Gate-Threshold Voltage	$V_{GS(th)}$	-1	-	-3	V	$V_{DS}=V_{GS}, I_D = -250\mu\text{A}$
Gate-Body Leakage Current	I_{GSS}	-	-	± 100	nA	$V_{GS}=\pm 20\text{V}$
Drain-Source Leakage Current	I_{DSS}	-	-	-1	uA	$V_{DS} = -24\text{V}, V_{GS}=0, T_J=25^\circ\text{C}$
		-	-	-25		$V_{DS} = -24\text{V}, V_{GS}=0, T_J=55^\circ\text{C}$
Drain-Source On-Resistance ²	$R_{DS(ON)}$	-	-	80	m Ω	$V_{GS} = -10\text{V}, I_D = -4\text{A}$
		-	-	120		$V_{GS} = -4.5\text{V}, I_D = -3\text{A}$
Forward Transconductance	g_{fs}	-	6	-	S	$V_{DS} = -5\text{V}, I_D = -4\text{A}$
Dynamic						
Total Gate Charge ²	Q_g	-	5.5	8.8	nC	$V_{DS} = -24\text{V},$ $V_{GS} = -4.5\text{V},$ $I_D = -4\text{A}$
Gate-Source Charge	Q_{gs}	-	1	-		
Gate-Drain Charge	Q_{gd}	-	2.6	-		
Turn-on Delay Time ²	$T_{d(on)}$	-	7	-	nS	$V_{DD} = -15\text{V},$ $V_{GS} = -10\text{V},$ $R_G = 3.3\Omega,$ $R_D = 15\Omega,$ $I_D = -1\text{A}$
Rise Time	T_r	-	6	-		
Turn-off Delay Time	$T_{d(off)}$	-	18	-		
Fall Time	T_f	-	4	-		
Input Capacitance	C_{iss}	-	400	640	pF	$V_{GS}=0\text{V}$ $V_{DS} = -25\text{V},$ $f=1.0\text{MHz}$
Output Capacitance	C_{oss}	-	90	-		
Reverse Transfer Capacitance	C_{rss}	-	30	-		
Source-Drain Diode						
Diode Forward Voltage ²	V_{SD}	-	-	-1.2	V	$I_S = -1.6\text{A}, V_{GS}=0\text{V}$
Reverse Recovery Time ²	T_{RR}	-	21	-	ns	$I_S = -4\text{A}, V_{GS}=0$
Reverse Recovery Charge	Q_{RR}	-	14	-	nC	$dI/dt=100\text{A}/\mu\text{s}$

Notes:

- Pulse width limited by safe operating area.
- Pulse width $\leq 300\mu\text{s}$, dutycycle $\leq 2\%$
- Surface mounted on 1 in² copper pad of FR4 board, 156 $^\circ\text{C}/\text{W}$ when mounted on Min. copper pad.

CHARACTERISTIC CURVES

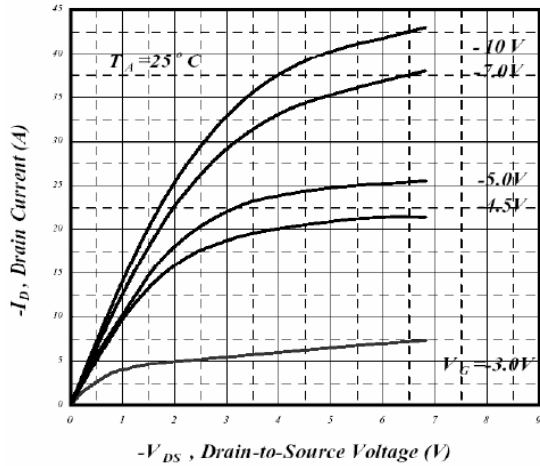

Fig 1. Typical Output Characteristics

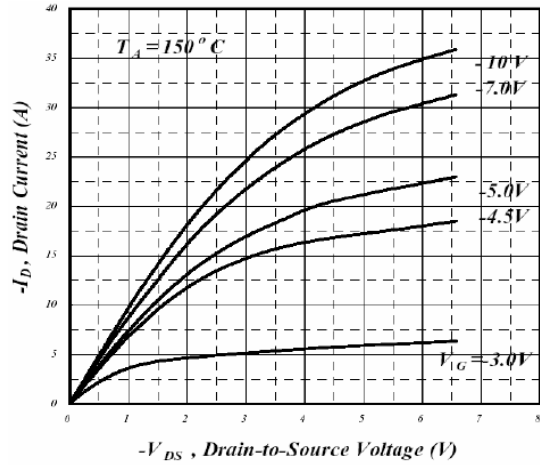

Fig 2. Typical Output Characteristics

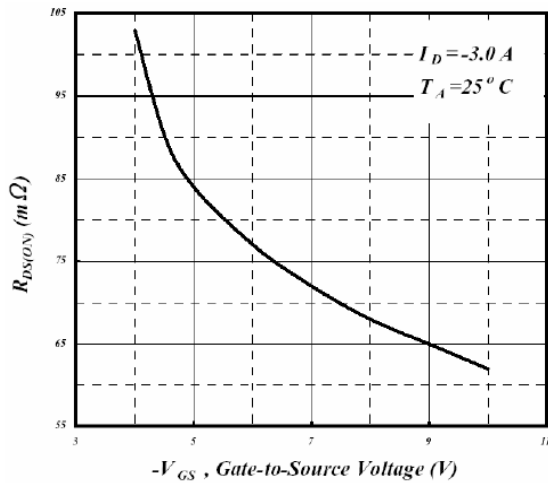

Fig 3. On-Resistance v.s. Gate Voltage

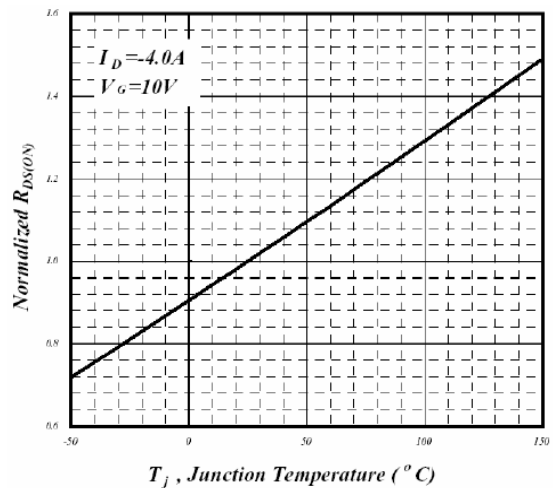

Fig 4. Normalized On-Resistance v.s. Junction Temperature

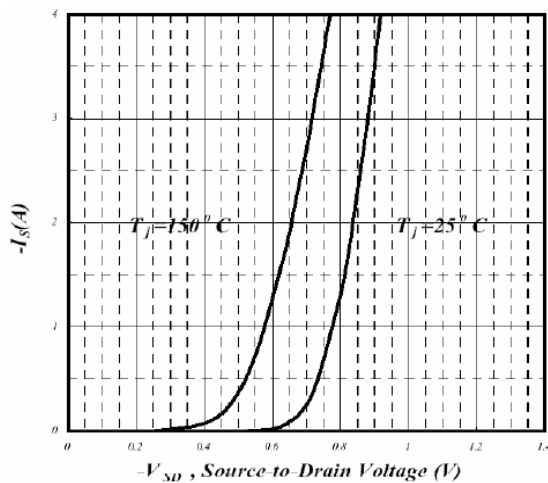

Fig 5. Forward Characteristics of Reverse Diode

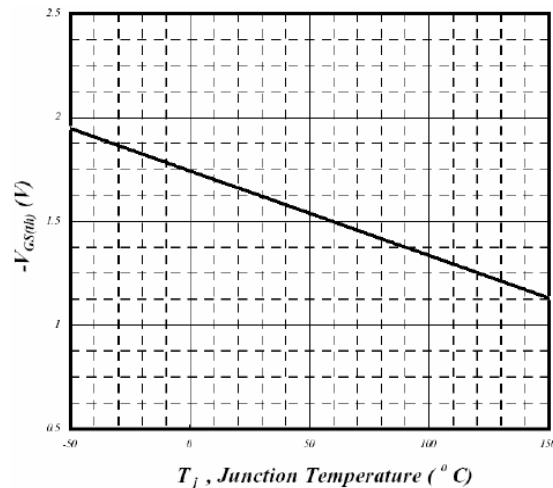

Fig 6. Gate Threshold Voltage v.s. Junction Temperature

CHARACTERISTIC CURVES

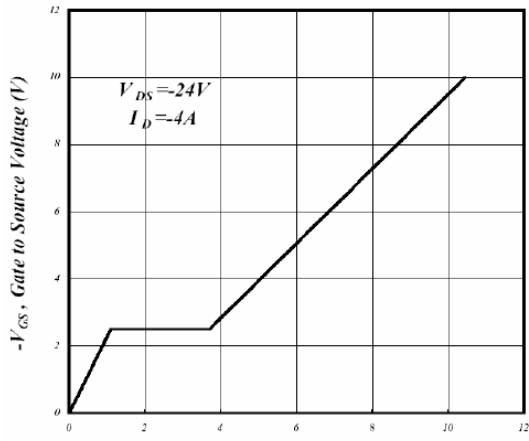

Fig 7. Gate Charge Characteristics

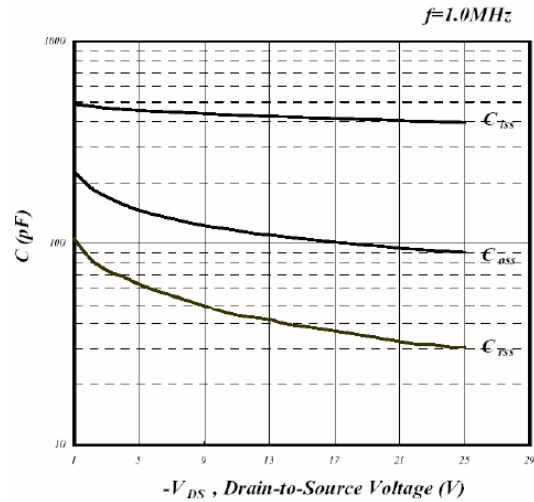

Fig 8. Typical Capacitance Characteristics

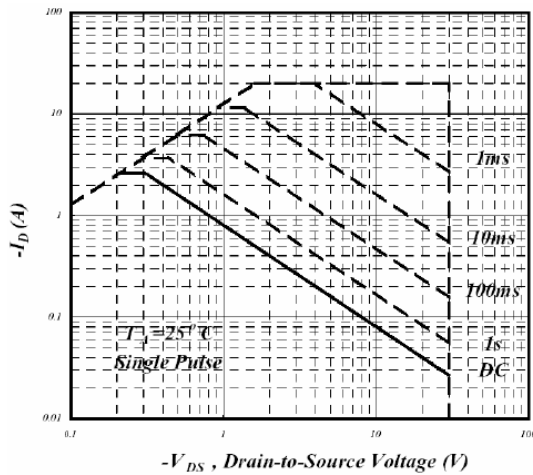

Fig 9. Maximum Safe Operating Area

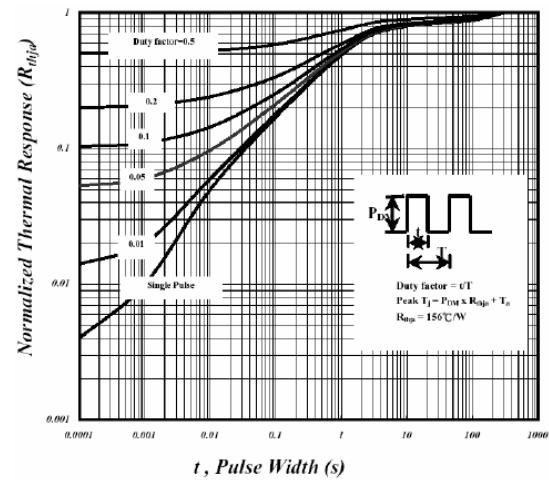

Fig 10. Effective Transient Thermal Impedance

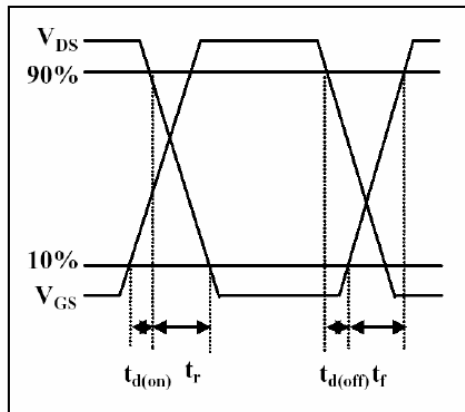

Fig 11. Switching Time Waveform

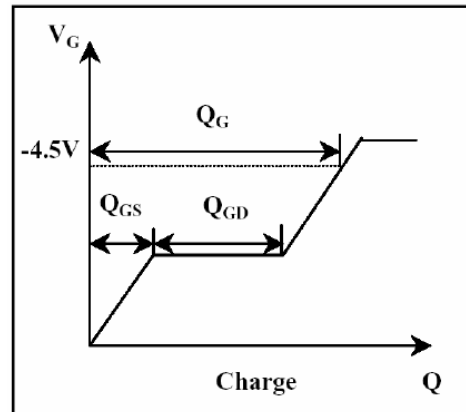

Fig 12. Gate Charge Waveform