

RoHS Compliant Product
A suffix of "-C" specifies halogen and lead-free

DESCRIPTION

SST2623J utilized advanced processing techniques to achieve the lowest possible on-resistance, extremely efficient and cost-effectiveness device. The SOT-26 package is universally used for all commercial-industrial applications.

FEATURES

- Simple Drive Requirement
- Smaller Outline Package
- Surface mount package

SOT-26

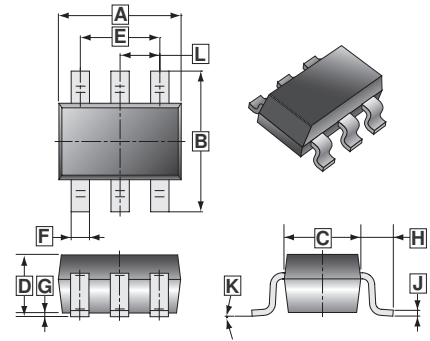

REF.	Millimeter		REF.	Millimeter	
	Min.	Max.		Min.	Max.
A	2.70	3.10	G	0	0.10
B	2.60	3.00	H	0.60	REF.
C	1.40	1.80	J	0.12	REF.
D	1.30	MAX.	K	0°	10°
E	1.90	REF.	L	0.95	REF.
F	0.30	0.50			

MARKING

2623

PACKAGE INFORMATION

Package	MPQ	Leader Size
SOT-26	3K	7 inch

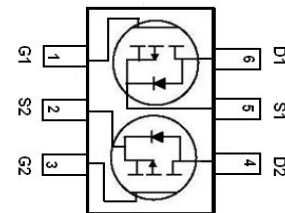

ABSOLUTE MAXIMUM RATINGS ($T_A=25^\circ\text{C}$ unless otherwise specified)

Parameter	Symbol	Ratings	Unit
Drain-Source Voltage	V_{DS}	-30	V
Gate-Source Voltage	V_{GS}	± 20	V
Continuous Drain Current	I_D	-3	A
Pulsed Drain Current ¹	I_{DM}	-20	A
Power Dissipation ²	P_D	0.35	W
Operating Junction and Storage Temperature Range	T_J, T_{STG}	150, -55~150	$^\circ\text{C}$
Thermal Resistance Rating			
Maximum Junction to Ambient	$R_{\theta JA}$	357	$^\circ\text{C} / \text{W}$

ELECTRICAL CHARACTERISTICS ($T_A=25^\circ\text{C}$ unless otherwise specified)

Parameter	Symbol	Min.	Typ.	Max.	Unit	Test Conditions
Static						
Drain-Source Breakdown Voltage	BV_{DSS}	-30	-	-	V	$V_{GS}=0V, I_D=-250\mu A$
Drain-Source Leakage Current	I_{DSS}	-	-	-1	μA	$V_{DS}=-30V, V_{GS}=0V$
Gate-Body Leakage Current	I_{GSS}	-	-	± 100	nA	$V_{DS}=0V, V_{GS}=\pm 20V$
Gate-Threshold Voltage	$V_{GS(th)}$	-1	-	-3	V	$V_{DS}=V_{GS}, I_D=-250\mu A$
Drain-Source On-Resistance ³	$R_{DS(ON)}$	-	-	130	m Ω	$V_{GS}=-10V, I_D=-3A$
		-	-	180		$V_{GS}=-4.5V, I_D=-2A$
Forward Transconductance	g_{fs}	-	2	-	S	$V_{DS}=-5V, I_D=-2A$
Diode Forward Voltage ³	V_{SD}	-	-	-1.2	V	$I_S=-1A, V_{GS}=0V$
Dynamic ⁴						
Input Capacitance	C_{iss}	-	240	-	pF	$V_{GS}=0V$ $V_{DS}=-25V,$ $f=1.0MHz$
Output Capacitance	C_{oss}	-	42	-		
Reverse Transfer Capacitance	C_{rss}	-	32	-		
Source-Drain Diode ^{3,4}						
Turn-on Delay Time	$T_{d(on)}$	-	5	-	nS	$V_{DD}=-15V,$ $V_{GS}=-10V,$ $R_G=3.3\Omega,$ $R_D=15\Omega,$ $I_D=-1A$
Rise Time	T_r	-	6	-		
Turn-off Delay Time	$T_{d(off)}$	-	15	-		
Fall Time	T_f	-	3	-		
Total Gate Charge	Q_g	-	4.5	-	nC	$V_{DS}=-24V,$ $V_{GS}=-4.5V,$ $I_D=-2A$
Gate-Source Charge	Q_{gs}	-	0.5	-		
Gate-Drain Charge	Q_{gd}	-	1.4	-		

Notes:

1. Pulse width limited by Max. junction temperature.
2. Per element must be exceeded.
3. Pulse Test : Pulse width $\leq 300\mu s$, duty cycle $\leq 2\%$
4. Guaranteed by design, not subject to production testing.

CHARACTERISTIC CURVES

Output Characteristics

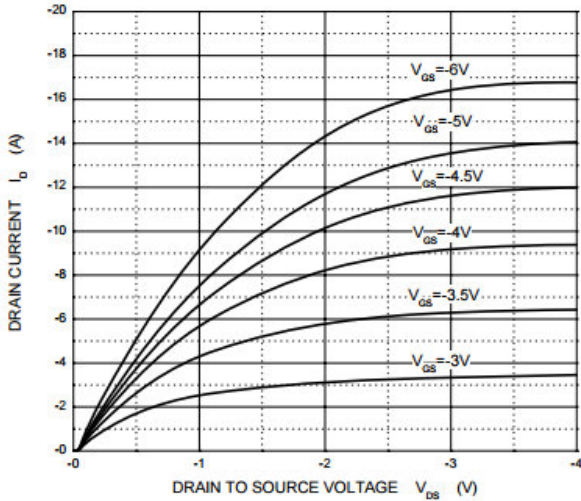

Transfer Characteristics

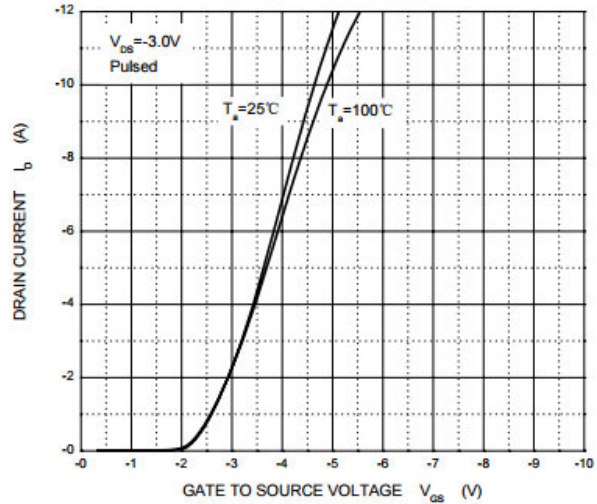

$R_{DS(ON)}$ — I_d

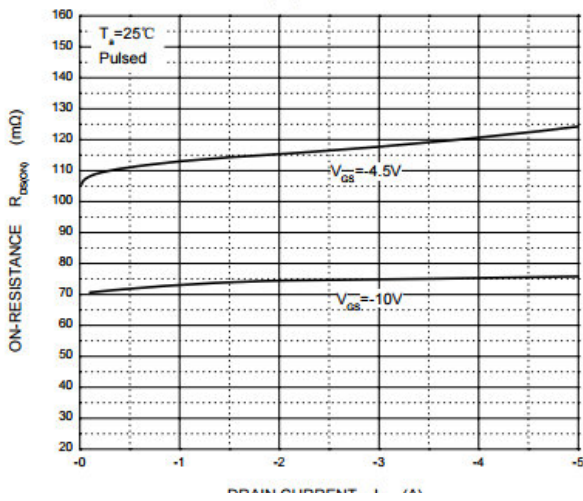

$R_{DS(ON)}$ — V_{gs}

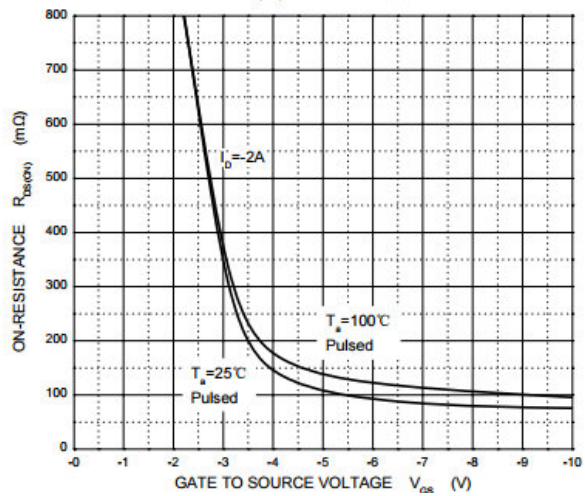

I_s — V_{sd}

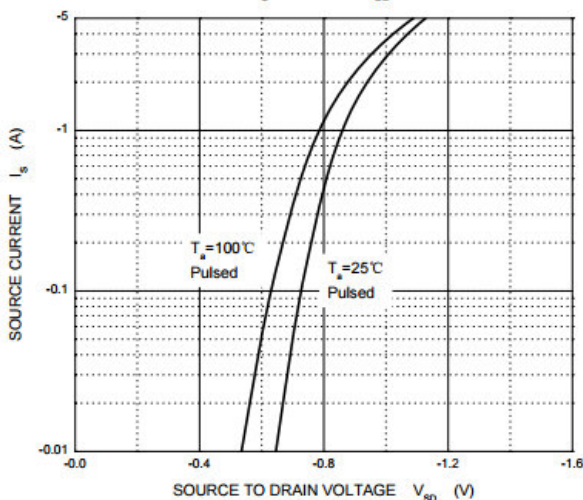

Threshold Voltage

