

RoHS Compliant Product

**TO-251**

**Description**

The TO-251 is universally preferred for all commercial-industrial surface mount applications and suited for low voltage applications such as DC/DC converters.

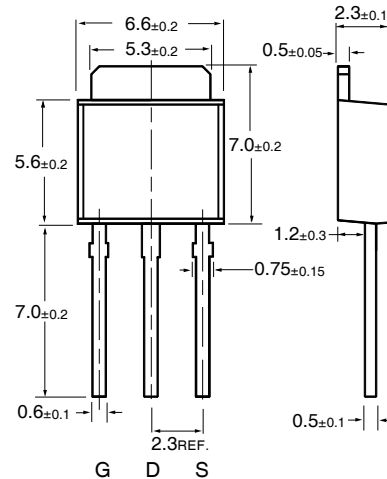

Dimensions in millimeters

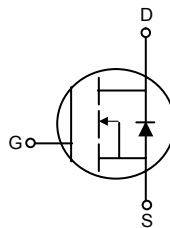

**Marking Code: 3055**

**XXXX(Date Code)**

**Absolute Maximum Ratings**

Parameter	Symbol	Ratings	Unit
Drain-Source Voltage	V <sub>DS</sub>	30	V
Gate-Source Voltage	V <sub>GS</sub>	± 20	V
Continuous Drain Current, V <sub>GS</sub> @10V	I <sub>D</sub> @T <sub>C</sub> =25°C	15	A
Continuous Drain Current, V <sub>GS</sub> @10V	I <sub>D</sub> @T <sub>C</sub> =100°C	9	A
Pulsed Drain Current <sup>1</sup>	I <sub>DM</sub>	50	A
Total Power Dissipation	P <sub>D</sub> @T <sub>C</sub> =25°C	28	W
Linear Derating Factor		0.22	W/°C
Operating Junction and Storage Temperature Range	T <sub>j</sub> , T <sub>stg</sub>	-55~+150	°C

**Thermal Data**

Parameter	Symbol	Ratings	Unit
Thermal Resistance Junction-case	R <sub>thj-c</sub>	4.5	°C/W
Thermal Resistance Junction-ambient	R <sub>thj-a</sub>	62	°C/W

## Electrical Characteristics( T<sub>j</sub>=25°C Unless otherwise specified)

Parameter	Symbol	Min.	Typ.	Max.	Unit	Test Condition
Drain-Source Breakdown Voltage	BV <sub>DSS</sub>	30	–	–	V	V <sub>GS</sub> =0V, I <sub>D</sub> =250uA
Breakdown Voltage Temp. Coefficient	ΔBV <sub>DSS</sub> /ΔT <sub>j</sub>	–	0.037	–	V/°C	Reference to 25°C, I <sub>D</sub> =1mA
Gate Threshold Voltage	V <sub>GS(th)</sub>	1.0	–	3.0	V	V <sub>DS</sub> =V <sub>GS</sub> , I <sub>D</sub> =250uA
Gate-Source Leakage Current	I <sub>GSS</sub>	–	–	±100	nA	V <sub>GS</sub> =±20V
Drain-Source Leakage Current (T <sub>j</sub> =25°C)	I <sub>DSS</sub>	–	–	25	uA	V <sub>DS</sub> =30V, V <sub>GS</sub> =0
Drain-Source Leakage Current(T <sub>j</sub> =150°C)		–	–	250	uA	V <sub>DS</sub> =24V, V <sub>GS</sub> =0
Static Drain-Source On-Resistance	R <sub>DS(ON)</sub>	–	14.5	16.5	mΩ	V <sub>GS</sub> =10V, I <sub>D</sub> =28A
		–	21.5	25		V <sub>GS</sub> =4.5V, I <sub>D</sub> =22A
Total Gate Charge <sup>2</sup>	Q <sub>g</sub>	–	5.4	–	nC	I <sub>D</sub> =8 A V <sub>DS</sub> =24V V <sub>GS</sub> =5V
Gate-Source Charge	Q <sub>gs</sub>	–	1.3	–		
Gate-Drain ("Miller") Charge	Q <sub>gd</sub>	–	3.6	–		
Turn-on Delay Time <sup>2</sup>	T <sub>d(ON)</sub>	–	3.6	–	nS	V <sub>DD</sub> =15V I <sub>D</sub> =8A V <sub>GS</sub> =10V R <sub>G</sub> =3.4Ω R <sub>D</sub> =1.9Ω
Rise Time	T <sub>r</sub>	–	19.8	–		
Turn-off Delay Time	T <sub>d(OFF)</sub>	–	13	–		
Fall Time	T <sub>f</sub>	–	3.2	–		
Input Capacitance	C <sub>iss</sub>	–	260	–	pF	V <sub>GS</sub> =0V V <sub>DS</sub> =25V f=1.0MHz
Output Capacitance	C <sub>oss</sub>	–	144	–		
Reverse Transfer Capacitance	C <sub>rss</sub>	–	13	–		

## Source-Drain Diode

Parameter	Symbol	Min.	Typ.	Max.	Unit	Test Condition
Forward On Voltage <sup>2</sup>	V <sub>SD</sub>	–	–	1.3	V	I <sub>S</sub> =15 A, V <sub>GS</sub> =0V, T <sub>j</sub> =25°C
Continuous Source Current(Body Diode)	I <sub>S</sub>	–	–	15	A	V <sub>D</sub> =V <sub>G</sub> =0V, V <sub>S</sub> =1.3 V
Pulsed Source Current(Body Diode) <sup>1</sup>	I <sub>SM</sub>	–	–	50	A	

Notes: 1.Pulse width limited by safe operating area.

2.Pulse width ≤300us, dutycycle ≤2%.

## Characteristics Curve

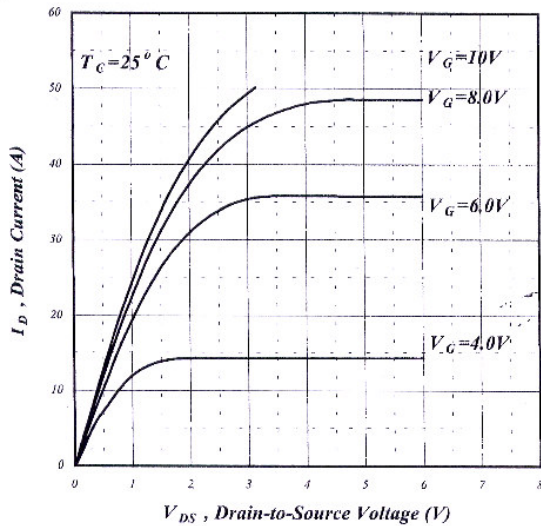

Fig 1. Typical Output Characteristics

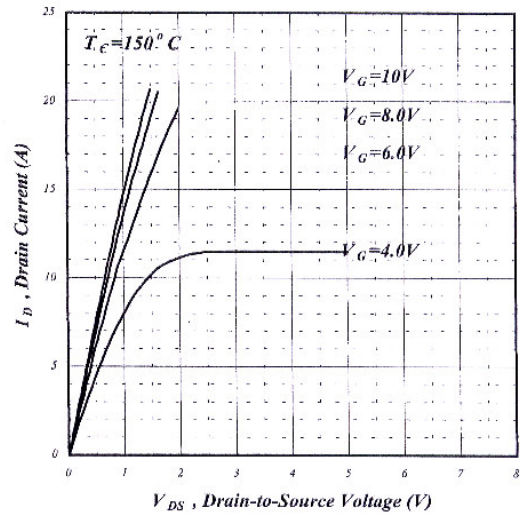

Fig 2. Typical Output Characteristics

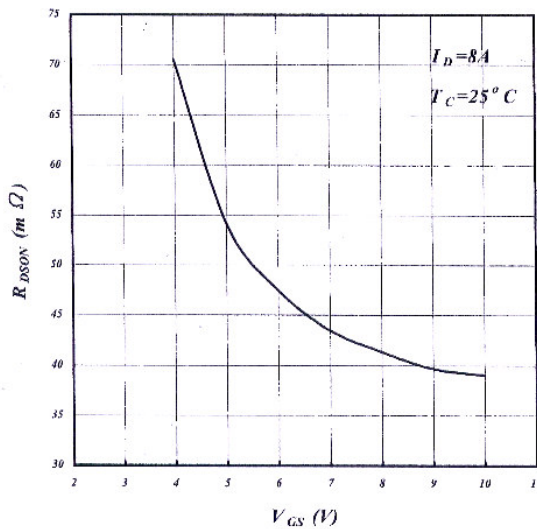

Fig 3. On-Resistance v.s. Gate Voltage

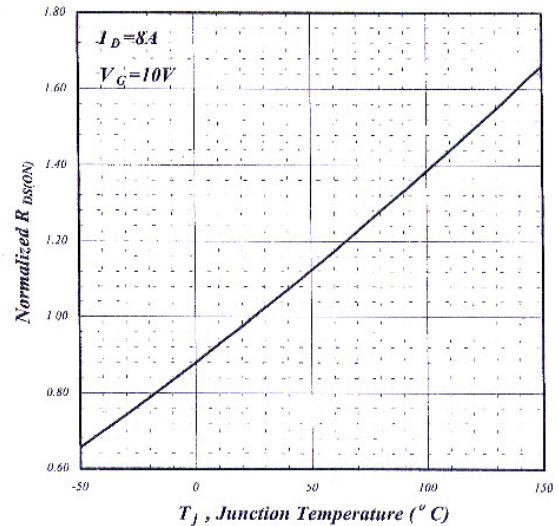

Fig 4. Normalized On-Resistance v.s. Junction Temperature

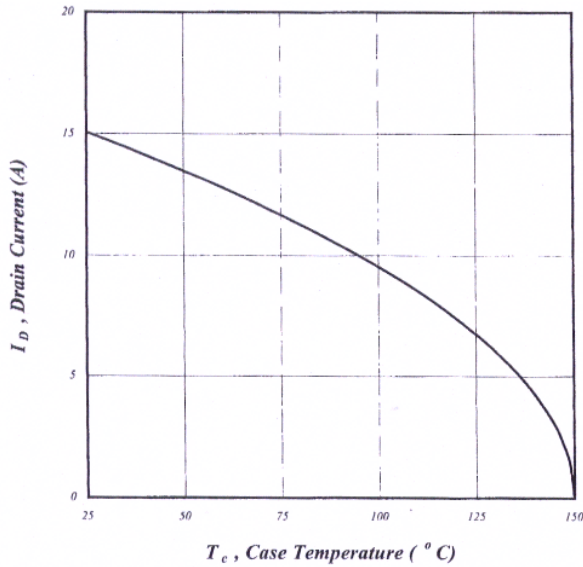

Fig 5. Maximum Drain Current v.s. Case Temperature

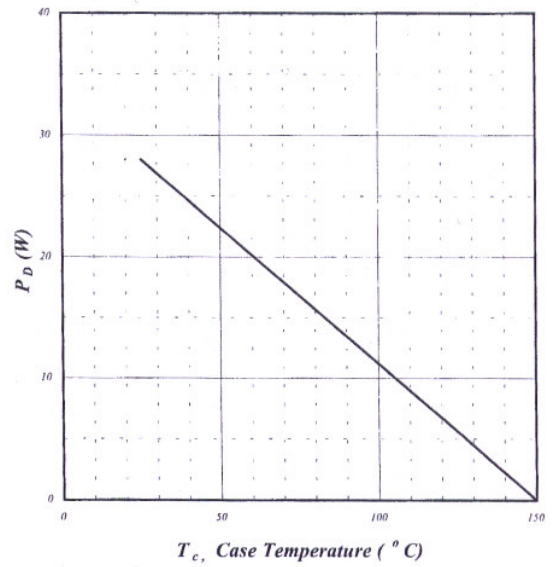

Fig 6. Typical Power Dissipation

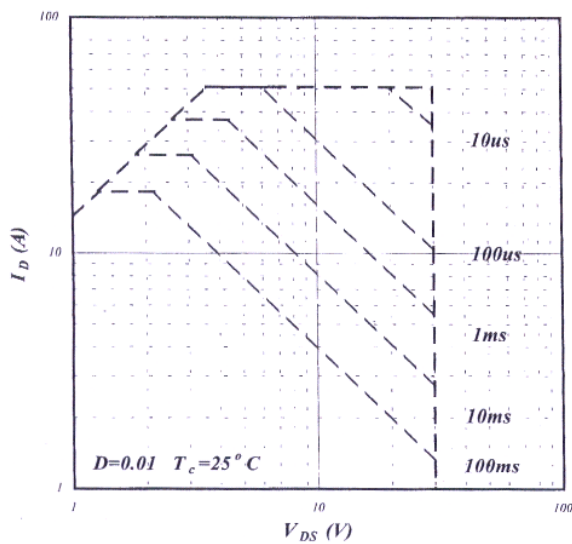

Fig 7. Maximum Safe Operating Area

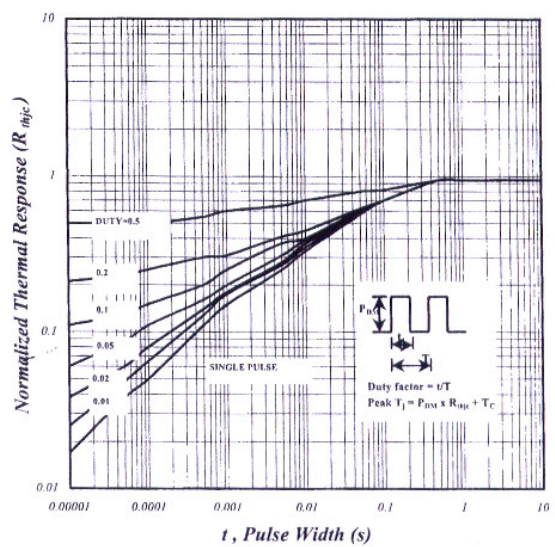

Fig 8. Effective Transient Thermal Impedance

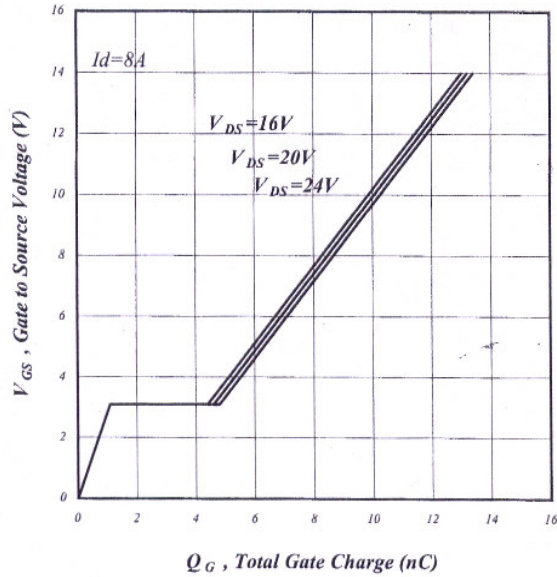

Fig 9. Gate Charge Characteristics

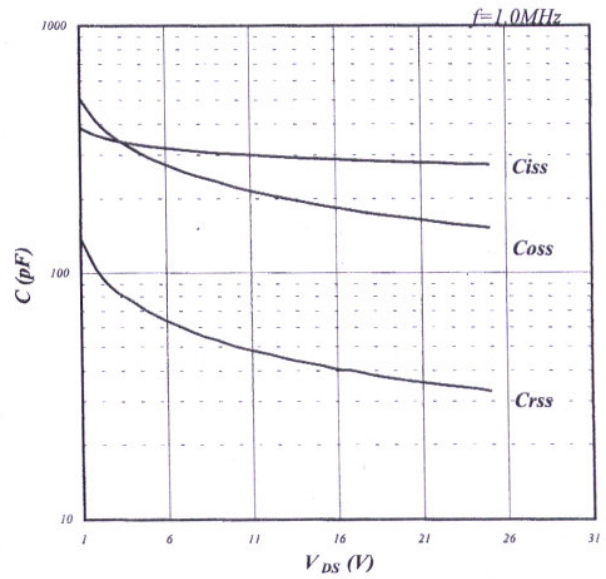

Fig 10. Typical Capacitance Characteristics

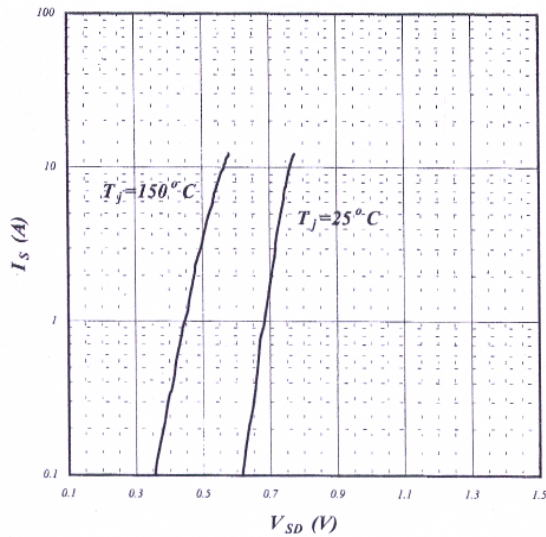

Fig 11. Forward Characteristic of Reverse Diode

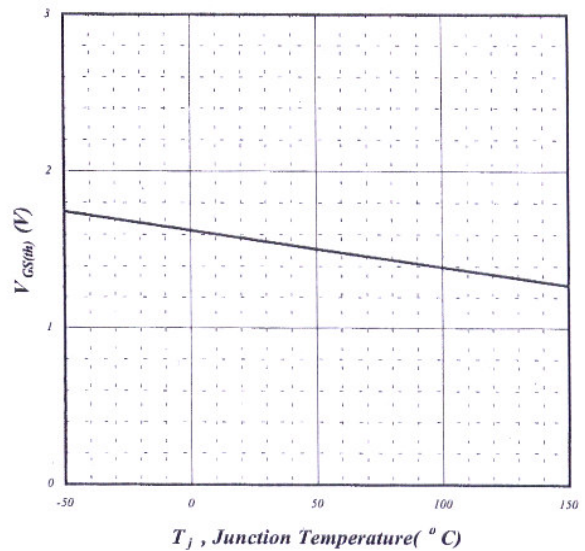

Fig 12. Gate Threshold Voltage v.s. Junction Temperature



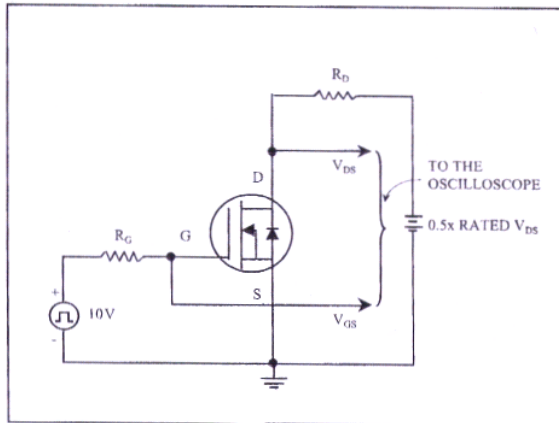

Fig 13. Switching Time Circuit

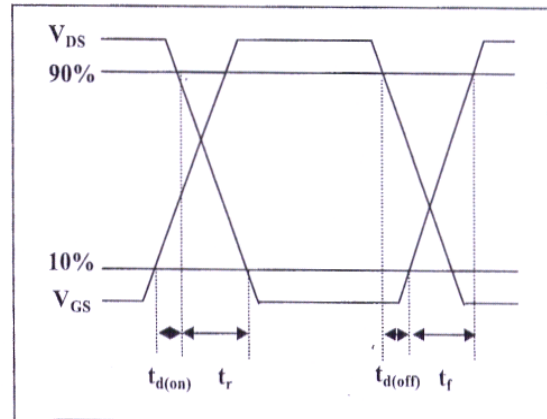

Fig 14. Switching Time Waveform

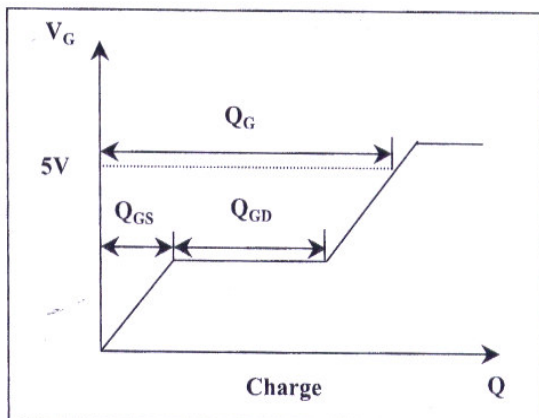

Fig 16. Gate Charge Waveform

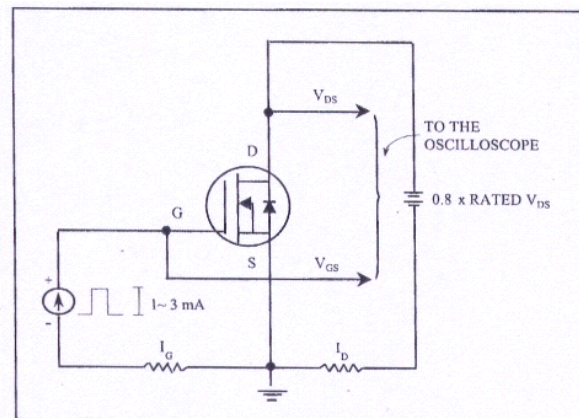

Fig 15. Gate Charge Circuit