

RoHS Compliant Product
 A suffix of "-C" specifies halogen free

DESCRIPTION

The SSD125N03S-C is the highest performance N-Ch MOSFETs with extreme high cell density, which provide excellent R_{DS(ON)} and gate charge for most of the synchronous buck converter applications.

The SSD125N03S-C meet the RoHS and Green Product requirement with full function reliability approved.

FEATURES

- High Speed Power Switching
- Super Low Gate Charge
- Green Device Available

MARKING

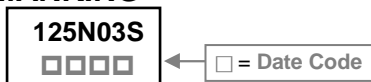

PACKAGE INFORMATION

Package	MPQ	Leader Size
TO-252	2.5K	13 inch

ORDER INFORMATION

Part Number	Type
SSD125N03S-C	Lead (Pb)-free and Halogen-free

TO-252(D-Pack)

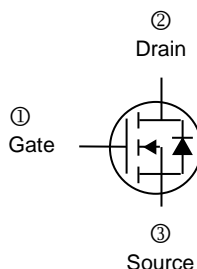
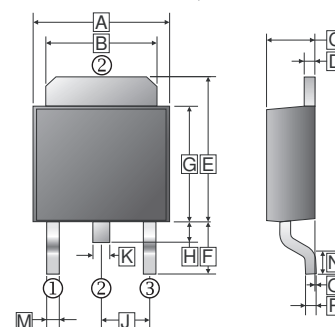
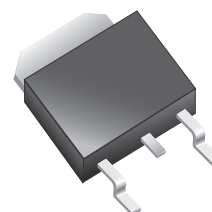

REF.	Millimeter		REF.	Millimeter	
	Min.	Max.		Min.	Max.
A	6.3	6.9	J	2.3 REF.	
B	4.95	5.53	K	0.89 REF.	
C	2.1	2.5	M	0.45	1.14
D	0.4	0.9	N	1.55 Typ.	
E	6	7.7	O	0	0.15
F	2.90 REF.		P	0.58 REF.	
G	5.4	6.4			
H	0.6	1.2			

ABSOLUTE MAXIMUM RATINGS

Parameter	Symbol	Ratings	Unit
Drain-Source Voltage	V _{DS}	30	V
Gate-Source Voltage	V _{GS}	±20	V
Continuous Drain Current ¹ @V _{GS} =10V	I _D	T _C =25°C	125
		T _C =100°C	79
Pulsed Drain Current ²	I _{DM}	200	A
Total Power Dissipation ³	P _D	44.6	W
Operating Junction and Storage Temperature Range	T _J , T _{STG}	-55~150	°C
Thermal Resistance Ratings			
Maximum Thermal Resistance Junction-Ambient ¹	R _{θJA}	62.5	°C/W
Maximum Thermal Resistance Junction-Case ¹	R _{θJC}	2.8	

ELECTRICAL CHARACTERISTICS ($T_J=25^\circ\text{C}$ unless otherwise specified)

Parameter	Symbol	Min.	Typ.	Max.	Unit	Test Conditions	
Drain-Source Breakdown Voltage	BV_{DSS}	30	-	-	V	$V_{GS}=0, I_D=250\mu\text{A}$	
Gate Threshold Voltage	$V_{GS(th)}$	1	-	2.5	V	$V_{DS}=V_{GS}, I_D=250\mu\text{A}$	
Forward Transconductance	g_{fs}	-	35	-	S	$V_{DS}=5\text{V}, I_D=20\text{A}$	
Gate-Source Leakage Current	I_{GSS}	-	-	± 100	nA	$V_{GS}=\pm 20\text{V}$	
Drain-Source Leakage Current	I_{DSS}	$T_J=25^\circ\text{C}$	-	-	1	μA	$V_{DS}=24\text{V}, V_{GS}=0$
		$T_J=55^\circ\text{C}$	-	-	5		$V_{DS}=24\text{V}, V_{GS}=0$
Static Drain-Source On-Resistance ²	$R_{DS(ON)}$	-	1.6	2.3	m Ω	$V_{GS}=10\text{V}, I_D=15\text{A}$	
		-	2	2.9		$V_{GS}=4.5\text{V}, I_D=15\text{A}$	
Total Gate Charge	Q_g	-	45	-	nC	$I_D=15\text{A}$ $V_{DS}=15\text{V}$ $V_{GS}=10\text{V}$	
Gate-Source Charge	Q_{gs}	-	9.8	-			
Gate-Drain Change	Q_{gd}	-	6.5	-			
Turn-on Delay Time	$T_{d(on)}$	-	10.3	-	nS	$V_{DD}=15\text{V}$ $I_D=15\text{A}$ $V_{GS}=10\text{V}$ $R_G=3.3\Omega$	
Rise Time	T_r	-	6.2	-			
Turn-off Delay Time	$T_{d(off)}$	-	56	-			
Fall Time	T_f	-	8.4	-			
Input Capacitance	C_{iss}	-	3420	-	pF	$V_{GS}=0$ $V_{DS}=15\text{V}$ $f=1\text{MHz}$	
Output Capacitance	C_{oss}	-	1916	-			
Reverse Transfer Capacitance	C_{rss}	-	196	-			
Source-Drain Diode							
Continuous Source Current ¹	I_S	-	-	125	A		
Pulsed Source Current ²	I_{SM}	-	-	200	A		
Diode Forward Voltage ²	V_{SD}	-	-	1.2	V	$V_{GS}=0, I_S=1\text{A}, T_J=25^\circ\text{C}$	

Notes:

- Surface Mounted on 1inch² FR4 Board with 2OZ copper.
- The data tested by pulsed, Pulse Width $\leq 300\mu\text{s}$, Duty Cycle $\leq 2\%$.
- The power dissipation is limited by 150 $^\circ\text{C}$, junction temperature.

TYPICAL CHARACTERISTICS CURVE

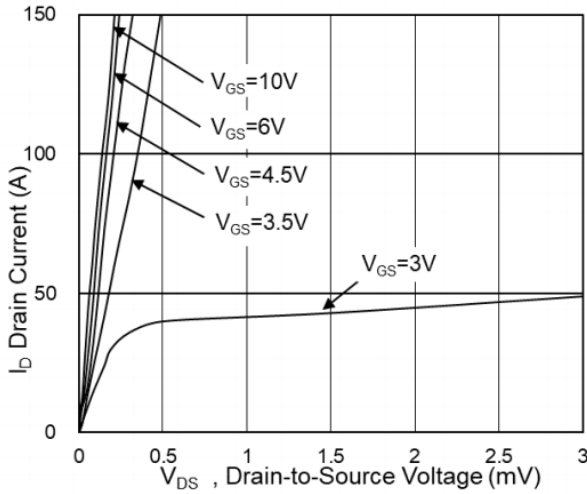

Fig.1 Typical Output Characteristics

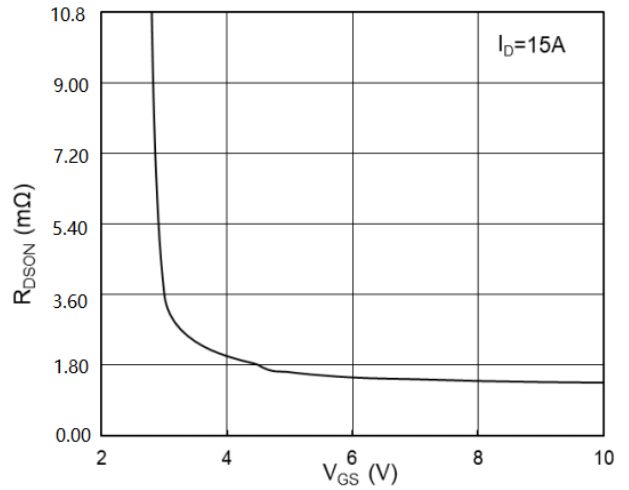

Fig.2 On-Resistance vs G-S Voltage

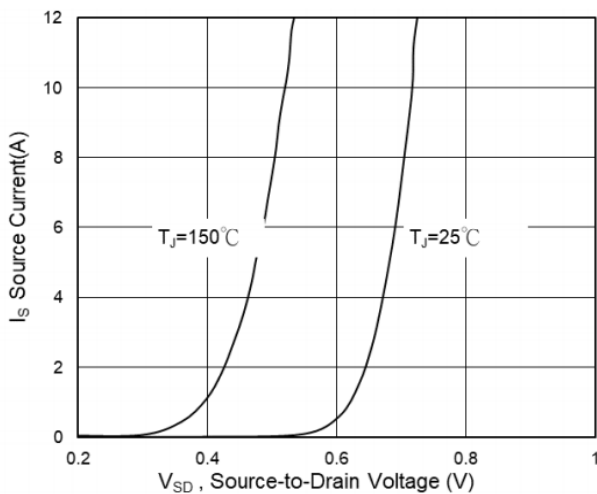

Fig.3 Source Drain Forward Characteristics

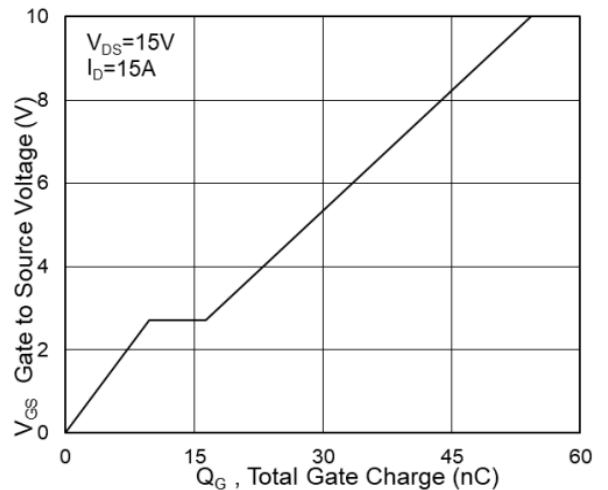

Fig.4 Gate-Charge Characteristics

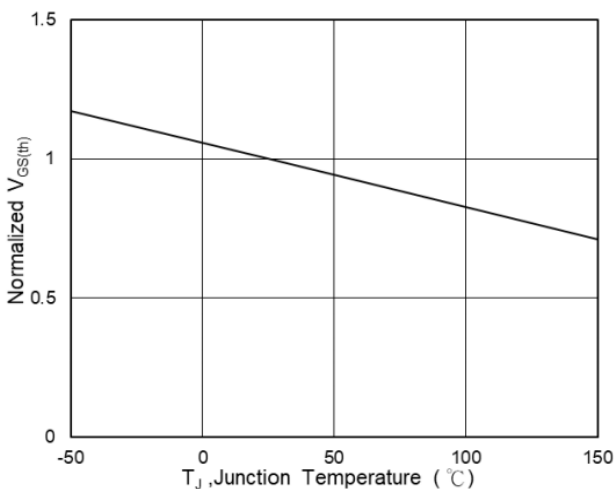

Fig.5 Normalized $V_{GS(th)}$ vs T_J

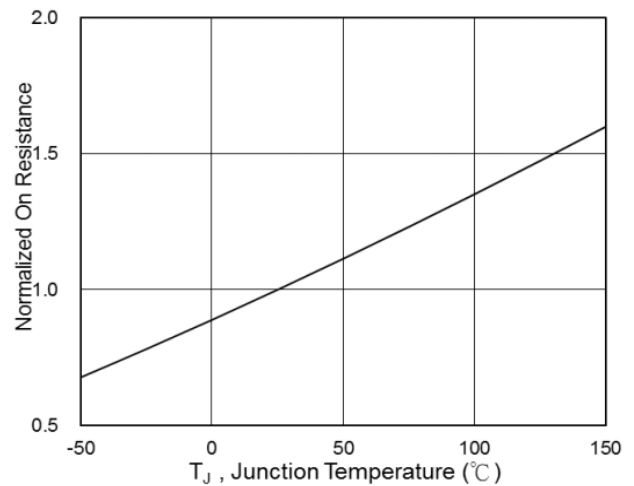

Fig.6 Normalized $R_{DS(on)}$ vs T_J

TYPICAL CHARACTERISTICS CURVE

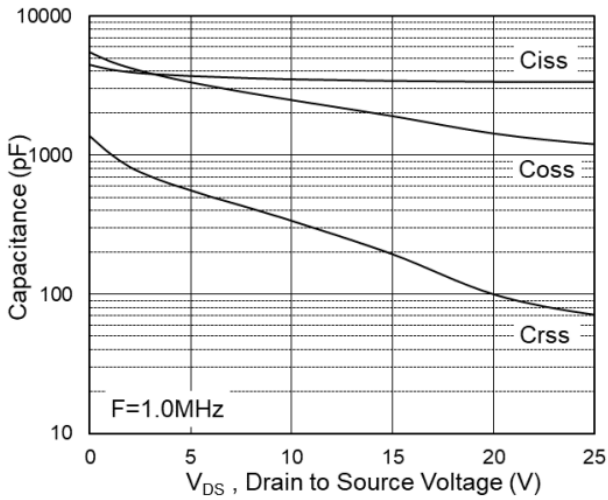

Fig.7 Capacitance

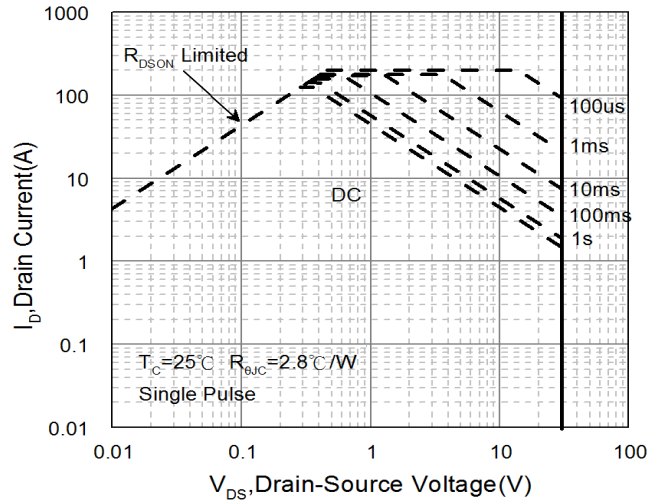

Fig.8 Safe Operating Area

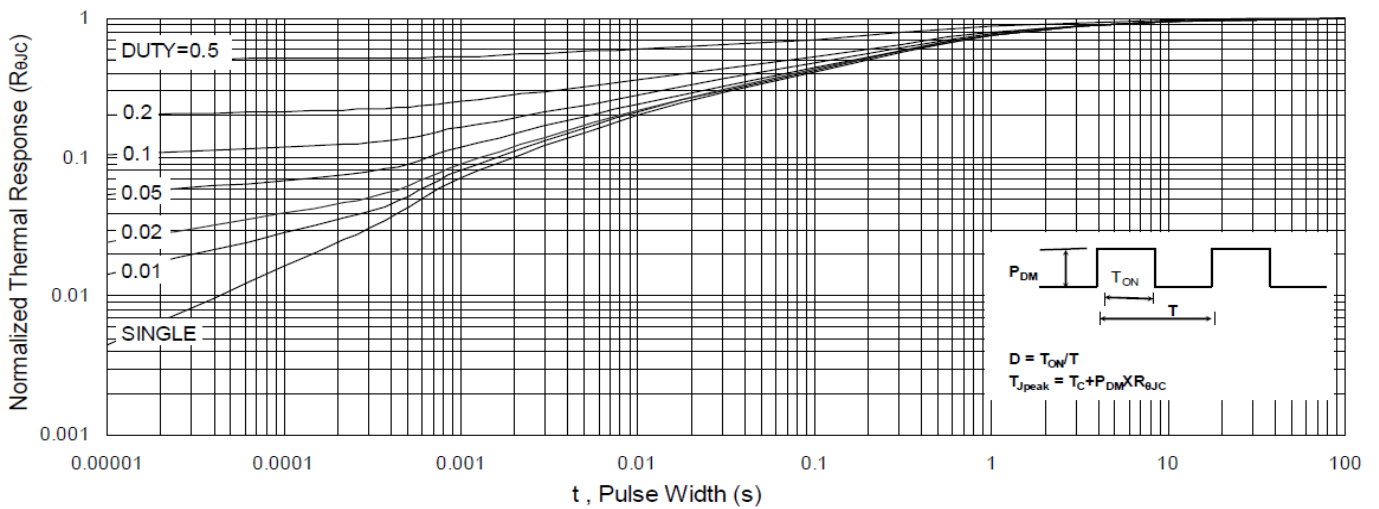

Fig.9 Normalized Maximum Transient Thermal Impedance

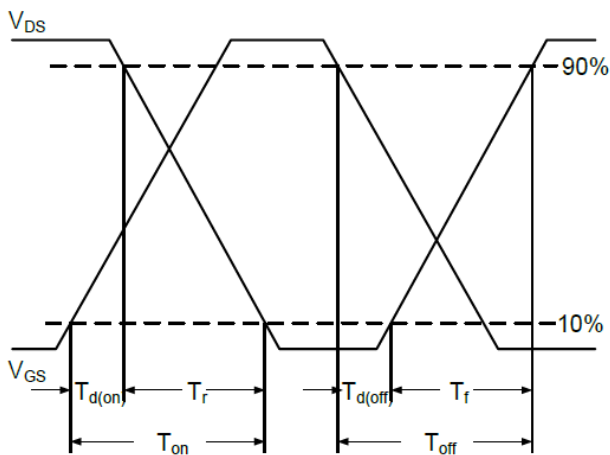

Fig.10 Switching Time Waveform

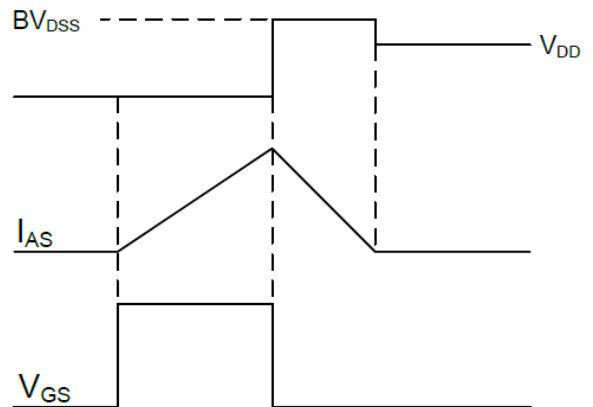

Fig.11 Unclamped Inductive Waveform