

RoHS Compliant Product  
A suffix of "-C" specifies halogen free

## DESCRIPTION

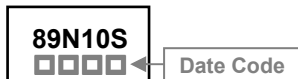
The SSU89N10S-C is the highest performance trench N-Ch MOSFETs with extreme high cell density, which provide excellent  $R_{DS(ON)}$  and gate charge for most of the synchronous buck converter applications.

The SSU89N10S-C meet the RoHS and Green Product requirement with full function reliability approved.

## FEATURES

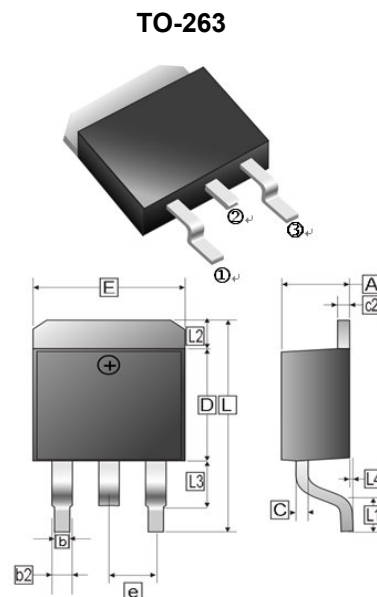
- High Speed Power Switching
- Super Low Gate Charge
- Green Device Available

## MARKING



## PACKAGE INFORMATION

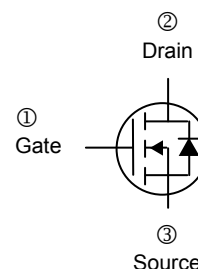
Package	MPQ	Leader Size
TO-263	0.8K	13 inch



REF.	Millimeter		REF.	Millimeter	
	Min.	Max.		Min.	Max.
A	4.00	4.87	c2	1.07	1.65
b	0.51	1.01	b2	1.34	REF
L4	0.00	0.30	D	8.0	9.65
C	0.30	0.74	e	2.54	REF
L3	1.50	REF	L	14.6	16.1
L1	2.5	REF	L2	1.27	REF
E	9.60	10.67			

## ORDER INFORMATION

Part Number	Type
SSU89N10S-C	Lead (Pb)-free and Halogen-free



## ABSOLUTE MAXIMUM RATINGS ( $T_A=25^\circ\text{C}$ unless otherwise specified)

Parameter	Symbol	Rating	Unit
Drain-Source Voltage	$V_{DS}$	100	V
Gate-Source Voltage	$V_{GS}$	$\pm 20$	V
Continuous Drain Current <sup>1</sup> @ $V_{GS}=10\text{V}$	$I_D$	$T_C=25^\circ\text{C}$	89
		$T_C=100^\circ\text{C}$	56
Pulsed Drain Current <sup>2</sup>	$I_{DM}$	220	A
Power Dissipation <sup>3</sup>	$P_D$	111.6	W
Operating Junction and Storage Temperature	$T_J, T_{STG}$	-55~150	$^\circ\text{C}$
<b>Thermal Resistance Rating</b>			
Thermal Resistance Junction-Ambient <sup>1</sup>	$R_{\theta JA}$	62	$^\circ\text{C} / \text{W}$
Thermal Resistance Junction-Case <sup>1</sup>	$R_{\theta JC}$	1.12	

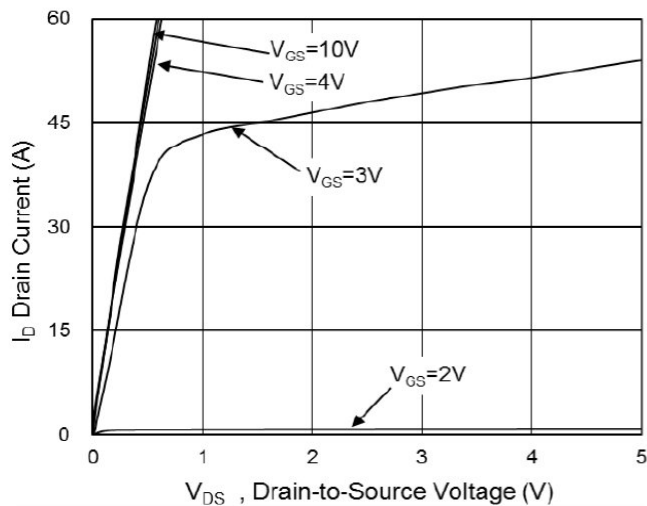
**ELECTRICAL CHARACTERISTICS** ( $T_J=25^\circ\text{C}$  unless otherwise specified)

Parameter	Symbol	Min.	Typ.	Max.	Unit	Test Conditions
Drain-Source Breakdown Voltage	$V_{(BR)DSS}$	100	-	-	V	$V_{GS}=0V, I_D=250\mu A$
Gate-Threshold Voltage	$V_{GS(th)}$	1	-	2.5	V	$V_{DS}=V_{GS}, I_D=250\mu A$
Forward Transconductance	$g_{fs}$	-	85	-	S	$V_{DS}=5V, I_D=20A$
Gate-Source Leakage Current	$I_{GSS}$	-	-	$\pm 100$	nA	$V_{GS}=\pm 20V$
Drain-Source Leakage Current	$I_{DSS}$	-	-	1	$\mu A$	$V_{DS}=80V, V_{GS}=0V, T_J=25^\circ\text{C}$
		-	-	5		$V_{DS}=80V, V_{GS}=0V, T_J=55^\circ\text{C}$
Static Drain-Source On-Resistance <sup>2</sup>	$R_{DS(ON)}$	-	-	9	m $\Omega$	$V_{GS}=10V, I_D=13.5A$
		-	-	11		$V_{GS}=4.5V, I_D=11.5A$
Total Gate Charge	$Q_g$	-	45	-	nC	$I_D=13.5A$ $V_{DS}=50V$ $V_{GS}=10V$
Gate-Source Charge	$Q_{gs}$	-	9.5	-		
Gate-Drain Charge	$Q_{gd}$	-	4.8	-		
Turn-on Delay Time	$T_{d(on)}$	-	10	-	nS	$V_{DD}=50V$ $I_D=13.5A$ $V_{GS}=10V$ $R_G=3\Omega$
Rise Time	$T_r$	-	6.5	-		
Turn-off Delay Time	$T_{d(off)}$	-	45	-		
Fall Time	$T_f$	-	7.5	-		
Input Capacitance	$C_{iss}$	-	3320	-	pF	$V_{GS}=0V$ $V_{DS}=50V$ $f=1\text{MHz}$
Output Capacitance	$C_{oss}$	-	605	-		
Reverse Transfer Capacitance	$C_{rss}$	-	20	-		
<b>Source-Drain Diode</b>						
Diode Forward Voltage <sup>2</sup>	$V_{SD}$	-	-	1.2	V	$I_S=1A, V_{GS}=0V$
Continuous Source Current <sup>1</sup>	$I_S$	-	-	89	A	$V_G=V_D=0, \text{Force Current}$
Reverse Recovery Time	$T_{rr}$	-	33	-	nS	$I_F=13.5A, di/dt=100A/\mu s,$
Reverse Recovery Charge	$Q_{rr}$	-	150	-	nC	$T_J=25^\circ\text{C}$

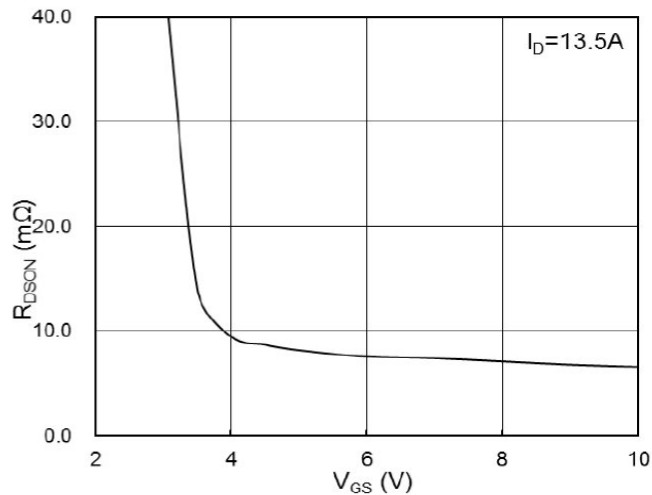
Notes:

1. The data tested by surface mounted on a 1 inch<sup>2</sup> FR-4 board with 20Z copper.
2. The data tested by pulsed pulse width  $\leq 300\mu s$ , duty cycle  $\leq 2\%$ .
3. The power dissipation is limited by 150°C junction temperature.

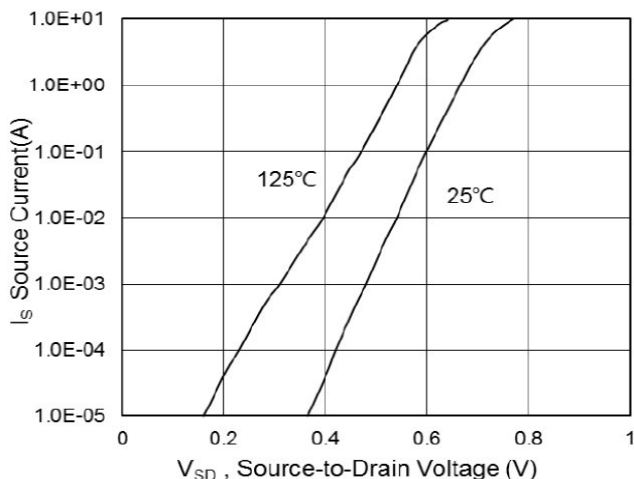
**CHARACTERISTIC CURVES**



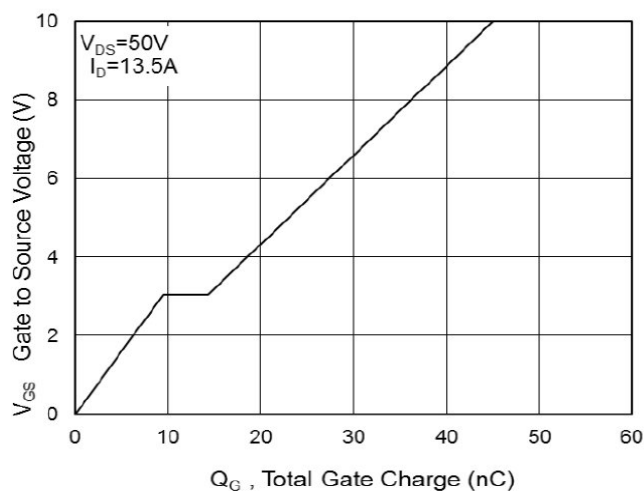
**Fig.1 Typical Output Characteristics**



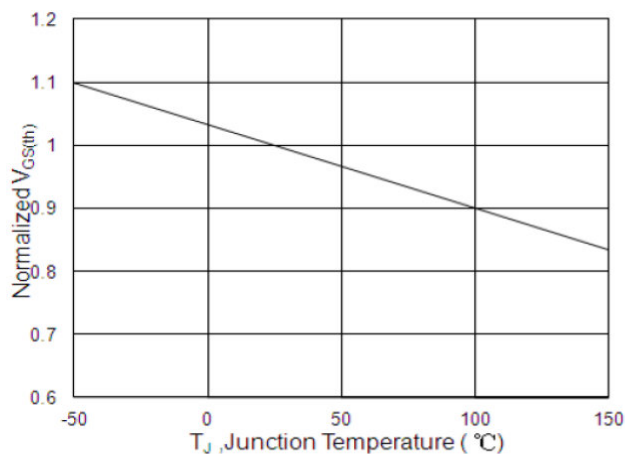
**Fig.2 On-Resistance vs G-S Voltage**



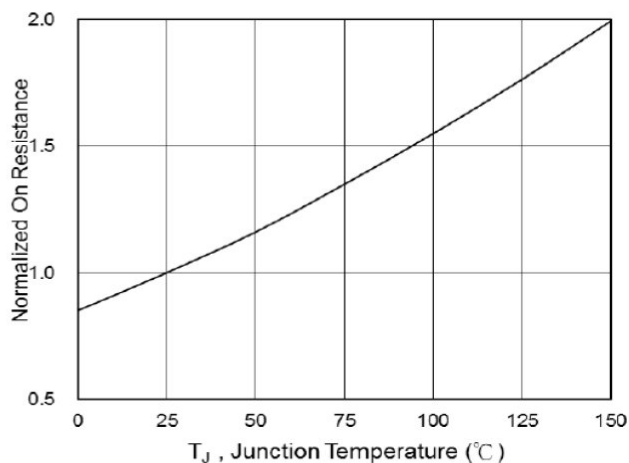
**Fig.3 Source-Drain Forward Characteristics**



**Fig.4 Gate-Charge Characteristics**

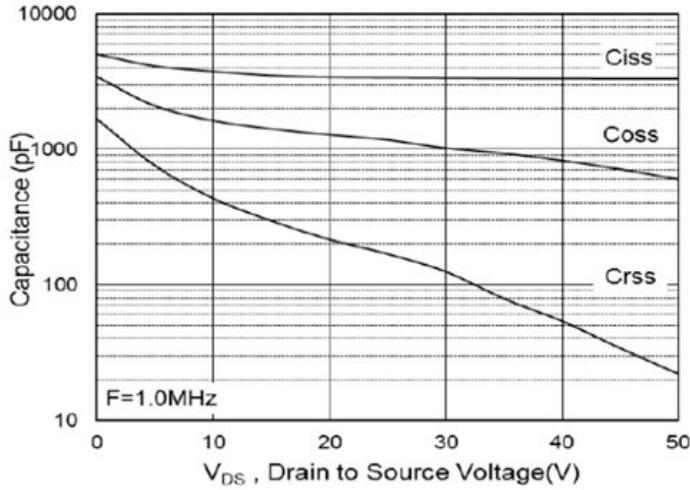


**Fig.5 Normalized  $V_{GS(th)}$  vs  $T_J$**

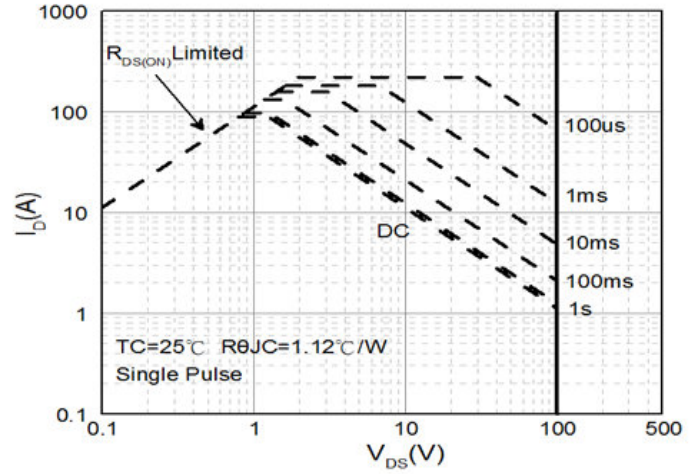


**Fig.6 Normalized  $R_{DS(ON)}$  vs  $T_J$**

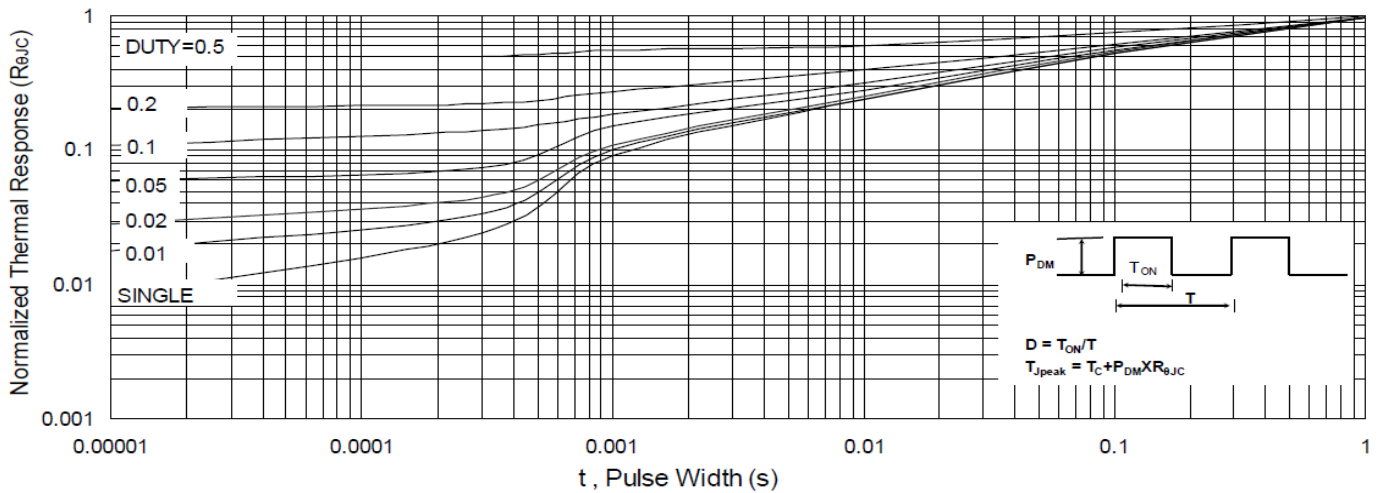
**CHARACTERISTIC CURVES**



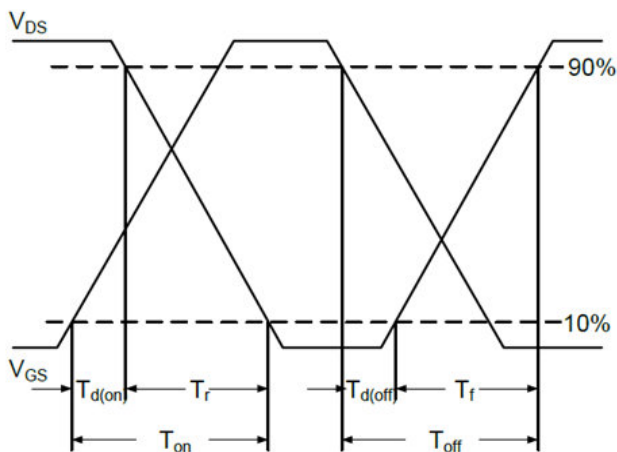
**Fig.7 Capacitance**



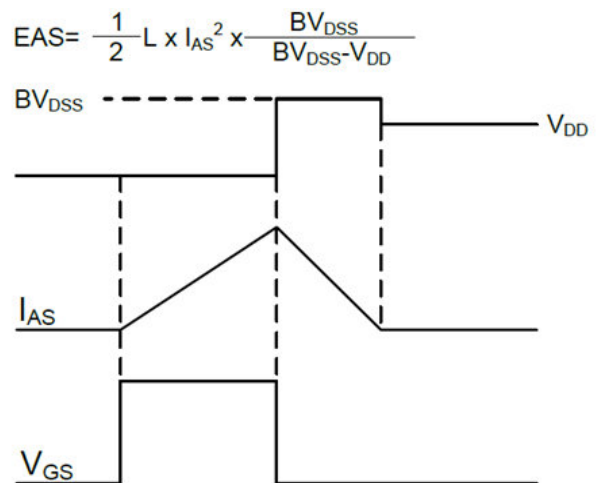
**Fig.8 Safe Operating Area**



**Fig.9 Normalized Maximum Transient Thermal Impedance**



**Fig.10 Switching Time Waveform**



**Fig.11 Unclamped Inductive Switching Waveform**