

RoHS Compliant Product
A suffix of "-C" specifies halogen & lead-free

FEATURES

- For AF Driver and Output Stages
- High Collector Current
- Low Collector-Emitter Saturation Voltage
- Complementary types: BCP51-C / BCP52-C / BCP53-C (PNP)

SOT-223

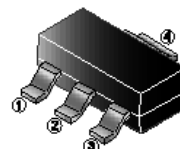

CLASSIFICATION OF h_{FE}

Product-Rank	BCP54-10-C	BCP55-10-C	BCP56-10-C
Range	63~160	63~160	63~160
Product-Rank	BCP54-16-C	BCP55-16-C	BCP56-16-C
Range	100~250	100~250	100~250

PACKAGE INFORMATION

Package	MPQ	Leader Size
SOT-223	2.5K	13 inch

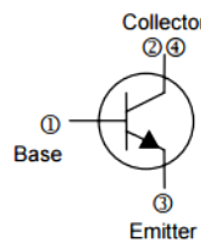

ORDER INFORMATION

Part Number	Type
BCP54/55/56-C	Lead (Pb)-free and Halogen-free

ABSOLUTE MAXIMUM RATINGS ($T_A=25^\circ\text{C}$ unless otherwise specified)

Parameter	Symbol	Ratings			Unit
		BCP54-C	BCP55-C	BCP56-C	
Collector-Base Voltage	V_{CBO}	45	60	100	V
Collector-Emitter Voltage	V_{CEO}	45	60	80	V
Emitter-Base Voltage	V_{EBO}	5			V
Collector Current-Continuous	I_C	1			A
Collector Power Dissipation	P_C	1.5			W
Thermal Resistance from Junction-Ambient	$R_{\theta JA}$	83.3			$^\circ\text{C/W}$
Operating Junction, Storage Temperature Range	T_J, T_{STG}	-55~150			$^\circ\text{C}$

ELECTRICAL CHARACTERISTICS ($T_A=25^\circ\text{C}$ unless otherwise specified)

Parameter	Symbol	Min.	Typ.	Max.	Unit	Test Conditions
Collector-Base Breakdown Voltage	BCP54-C	45	-	-	V	$I_C=0.1\text{mA}, I_E=0$
	BCP55-C	60	-	-		
	BCP56-C	100	-	-		
Collector-Emitter Breakdown Voltage	BCP54-C	45	-	-	V	$I_C=10\text{mA}, I_B=0$
	BCP55-C	60	-	-		
	BCP56-C	80	-	-		
Emitter-Base Breakdown Voltage	$V_{(BR)EBO}$	5	-	-	V	$I_E=10\mu\text{A}, I_C=0$
Collector Cut-off Current	I_{CBO}	-	-	100	nA	$V_{CB}=30\text{V}, I_E=0$
DC Current Gain	h_{FE}	25	-	-		$V_{CE}=2\text{V}, I_C=5\text{mA}$
		63	-	250		$V_{CE}=2\text{V}, I_C=150\text{mA}$
		25	-	-		$V_{CE}=2\text{V}, I_C=500\text{mA}$
Collector-Emitter Saturation Voltage	$V_{CE(sat)}$	-	-	0.5	V	$I_C=500\text{mA}, I_B=50\text{mA}$
Base-Emitter Voltage	$V_{BE(on)}$	-	-	1	V	$V_{CE}=2\text{V}, I_C=500\text{mA}$
Transition Frequency	f_T	100	-	-	MHz	$V_{CE}=10\text{V}, I_C=50\text{mA}, f=100\text{MHz}$

CHARACTERISTIC CURVES

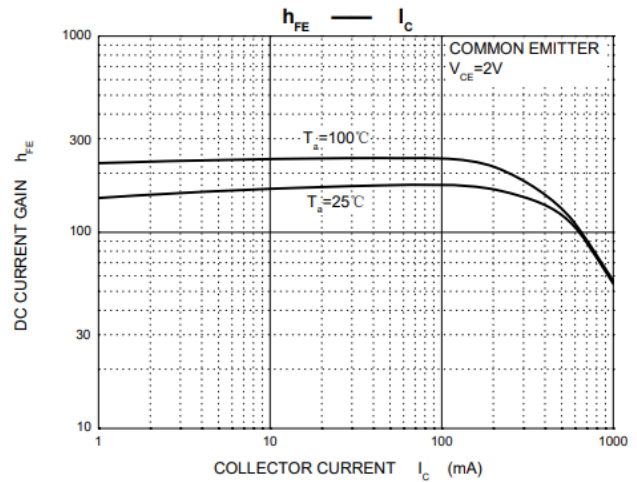
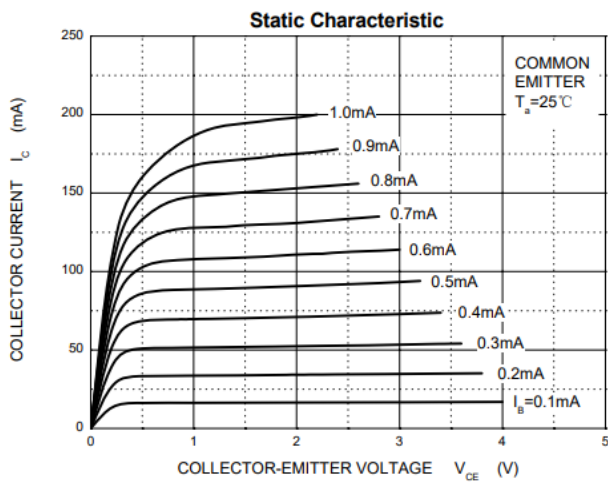

CHARACTERISTIC CURVES

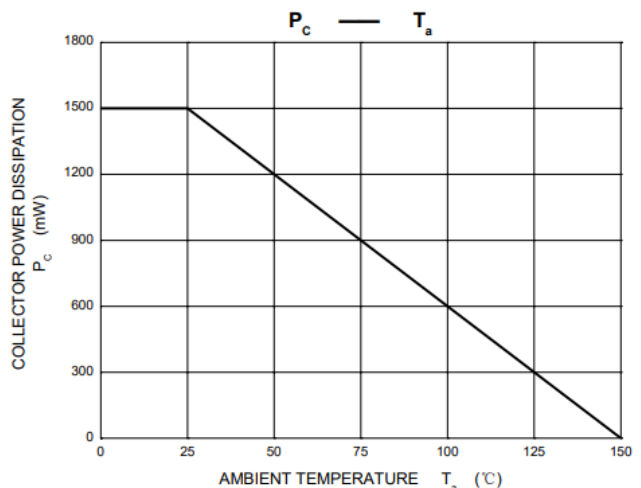
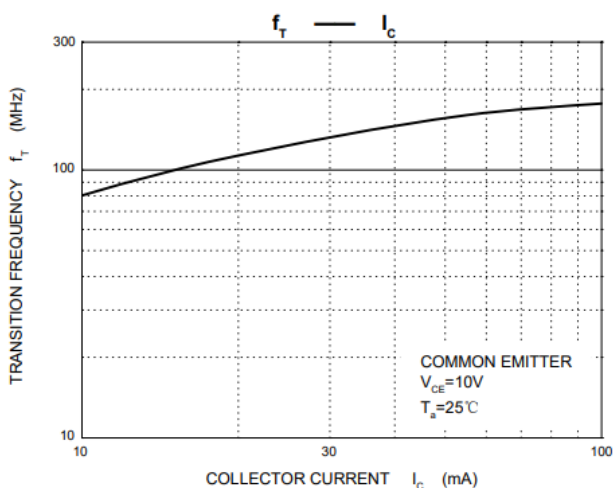
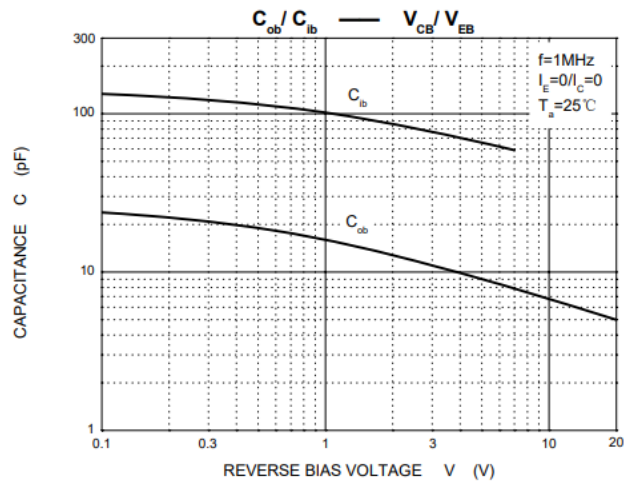
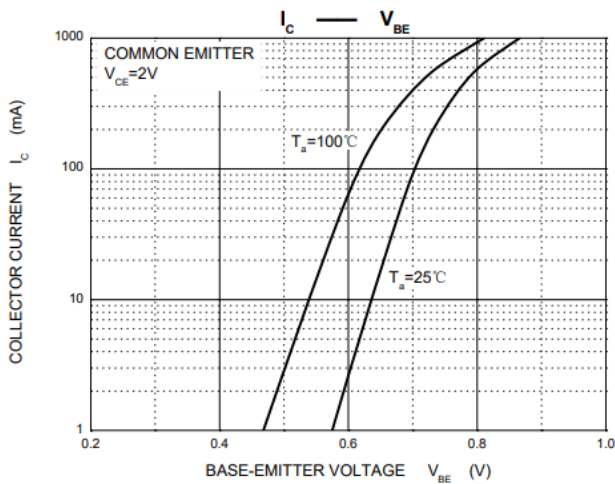
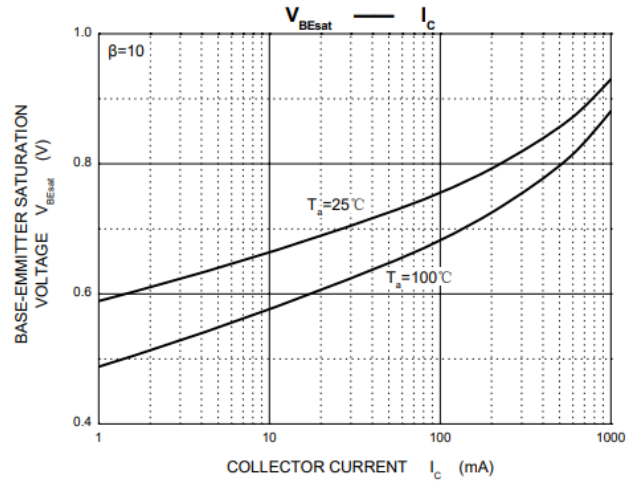
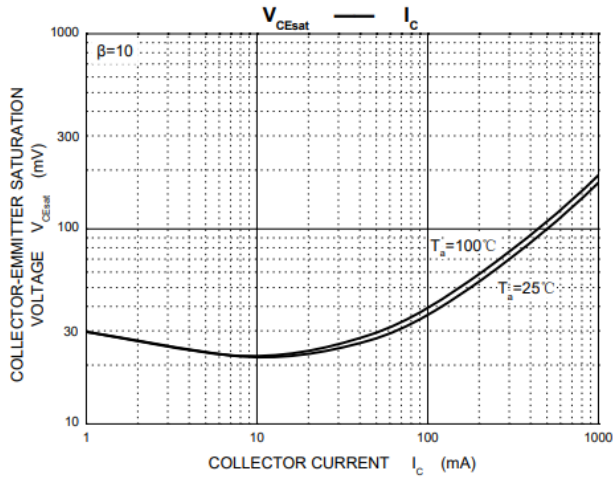

PACKAGE OUTLINE DIMENSIONS

SOT-223

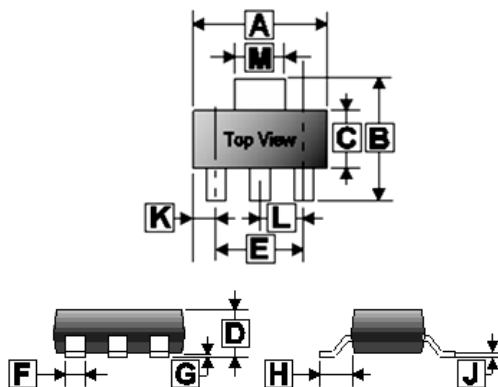

REF.	Millimeter	
	Min.	Max.
A	5.90	6.70
B	6.70	7.30
C	3.30	3.80
D	1.40	1.90
E	4.60 REF.	
F	0.60	0.85
G	-	0.18
H	2.00 REF.	
J	0.20	0.40
K	1.10 REF.	
L	2.30 REF.	
M	2.80	3.20

MOUNTING PAD LAYOUT

SOT-223

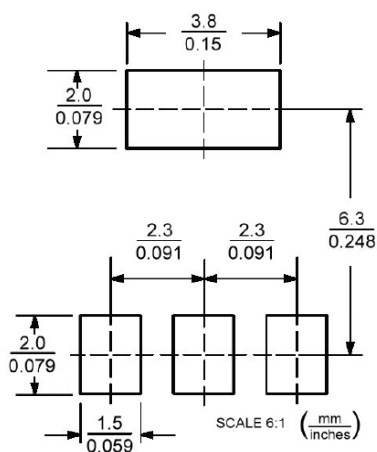

*Dimensions in millimeters