

A suffix of "-C" specifies halogen & lead-free

FEATURES

- General Purpose Transistor NPN Type
- Collect current : 0.1A
- Operating Temp. : -55°C ~ +150°C
- RoHS compliant product

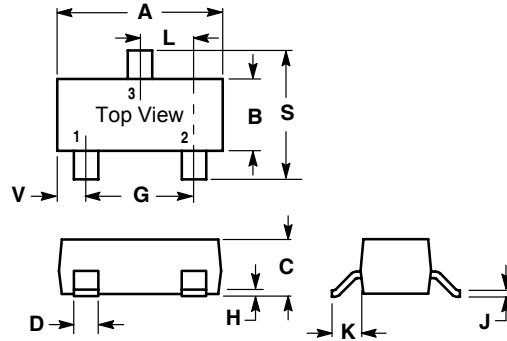
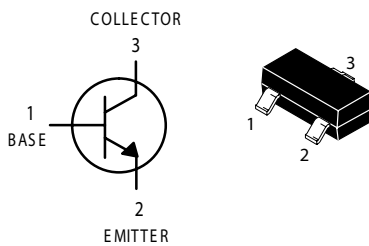

SOT-23		
Dim	Min	Max
A	2.800	3.040
B	1.200	1.400
C	0.890	1.110
D	0.370	0.500
G	1.780	2.040
H	0.013	0.100
J	0.085	0.177
K	0.450	0.600
L	0.890	1.020
S	2.100	2.500
V	0.450	0.600
All Dimension in mm		

ELECTRICAL CHARACTERISTICS (Tamb=25°C unless otherwise specified)

Parameter	Symbol	Test conditions	MIN	MAX	UNIT
Collector-base breakdown voltage	BC846	$I_C = 10 \mu A, I_E = 0$	80		V
	BC847		50		
	BC848		30		
Collector-emitter breakdown voltage	BC846	$I_C = 10 mA, I_B = 0$	65		V
	BC847		45		
	BC848		30		
Emitter-base breakdown voltage	V_{EBO}	$I_E = 10 \mu A, I_C = 0$	6		V
Collector cut-off current	BC846	$V_{CB} = 70 V, I_E = 0$			μA
	BC847		$V_{CB} = 50 V, I_E = 0$	0.1	
	BC848		$V_{CB} = 30 V, I_E = 0$		
Collector cut-off current	BC846	$V_{CE} = 60 V, I_B = 0$			μA
	BC847		$V_{CE} = 45 V, I_B = 0$	0.1	
	BC848		$V_{CE} = 30 V, I_B = 0$		
Emitter cut-off current	I_{EBO}	$V_{EB} = 5 V, I_C = 0$		0.1	μA
DC current gain	BC846A,847A,848A	$V_{CE} = 5V, I_C = 2mA$	110	220	
	BC846B,847B,848B		200	450	
	BC847C,BC848C		420	800	
Collector-emitter saturation voltage	$V_{CE(sat)}$	$I_C = 100mA, I_B = 5 mA$		0.5	V
Base-emitter saturation voltage	$V_{BE(sat)}$	$I_C = 100 mA, I_B = 5mA$		1.1	V
Transition frequency	f_T	$V_{CE} = 5 V, I_C = 10mA$ $f = 100MHz$	100		MHz

DEVICE MARKING

BC846A=1A; BC846B=1B; BC847A=1E; BC847B=1F; BC847C=1G; BC848A=1J; BC848B=1K; BC848C=1L

Typical Characteristics

BC846A/B, BC847A/B, BC848A/B

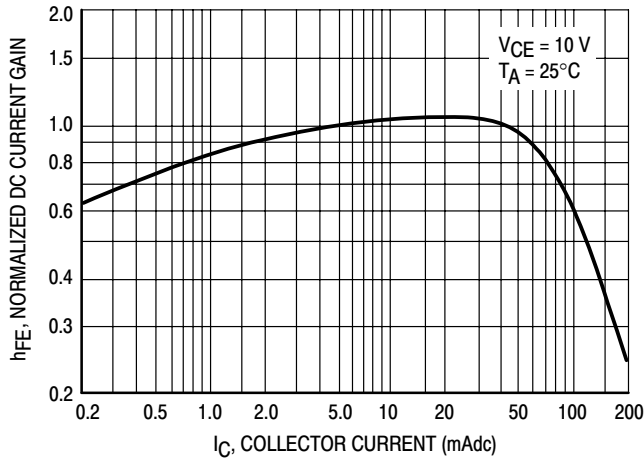

Figure 1. Normalized DC Current Gain

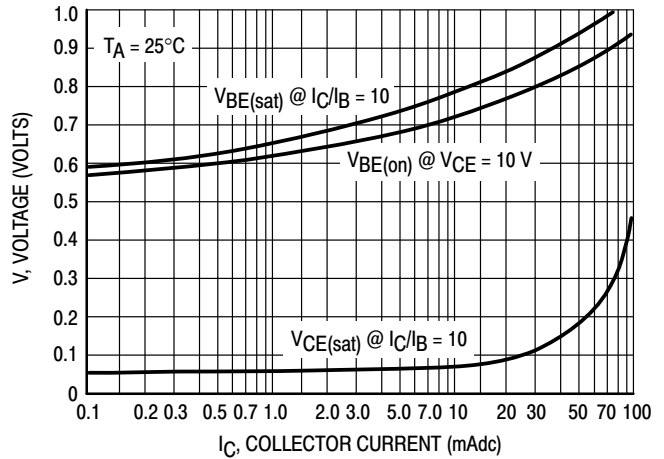

Figure 2. "Saturation" and "On" Voltages

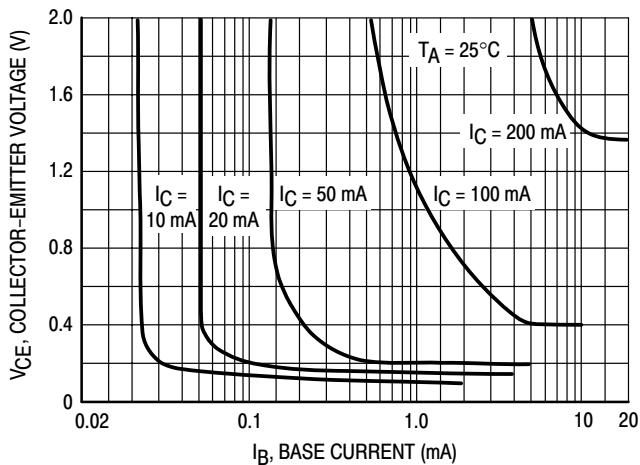

Figure 3. Collector Saturation Region

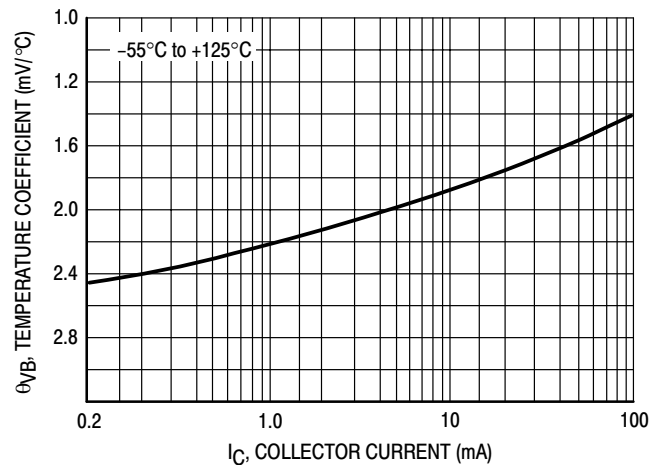

Figure 4. Base-Emitter Temperature Coefficient

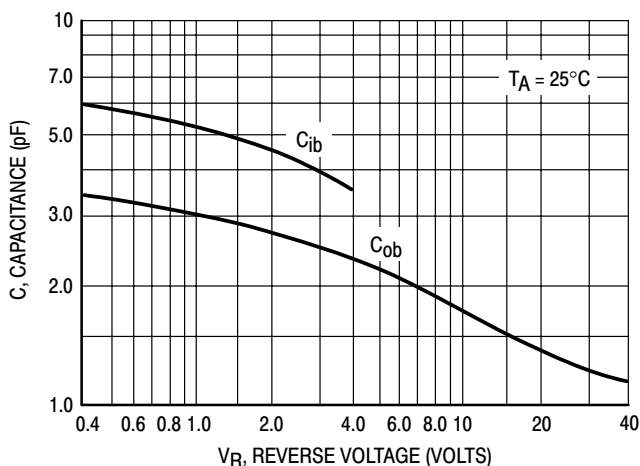

Figure 5. Capacitances

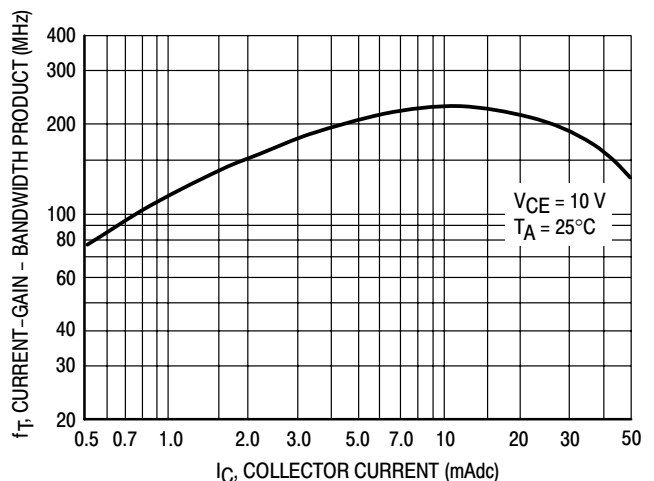

Figure 6. Current-Gain - Bandwidth Product

BC846A/B, BC847A/B, BC848A/B

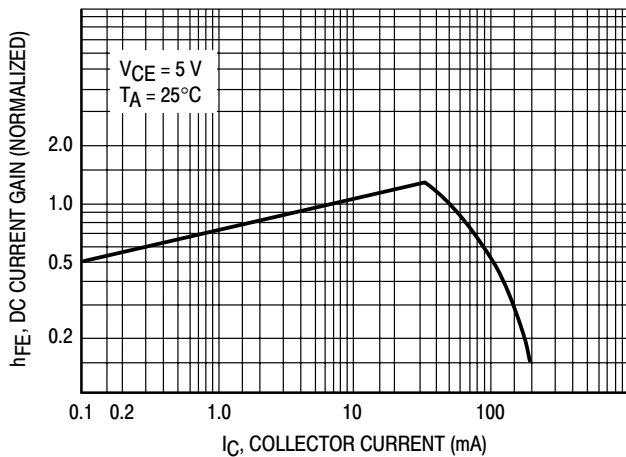

Figure 7. DC Current Gain

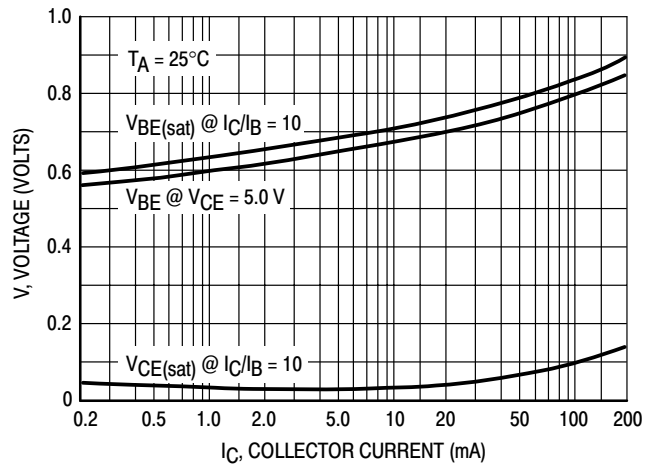

Figure 8. "On" Voltage

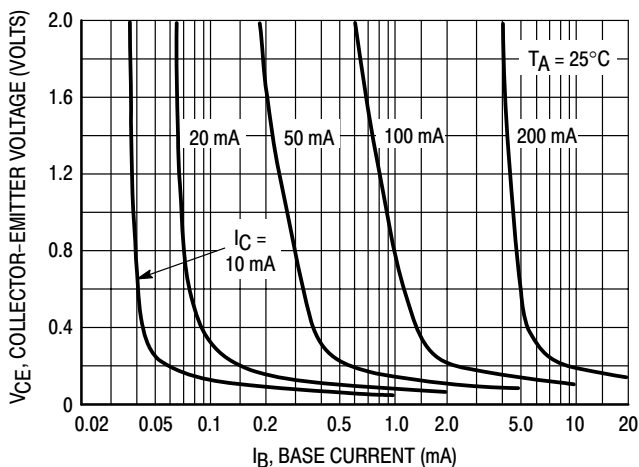

Figure 9. Collector Saturation Region

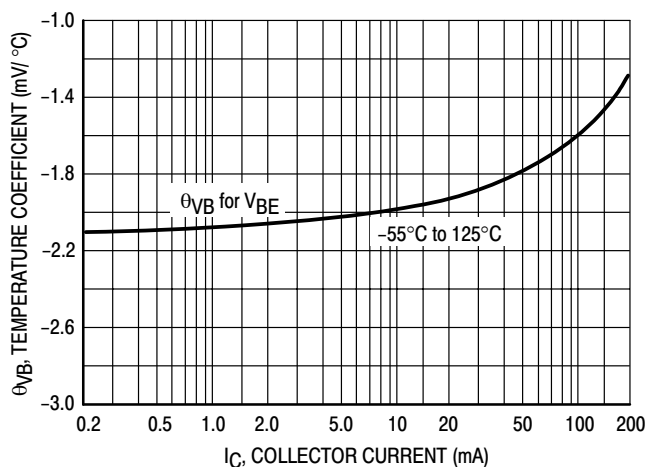

Figure 10. Base-Emitter Temperature Coefficient

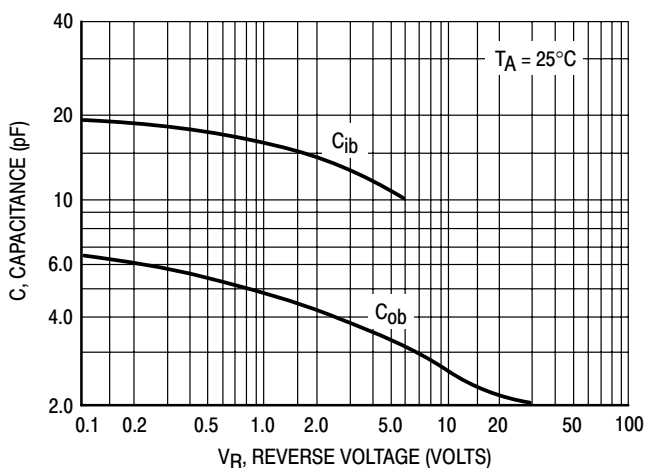

Figure 11. Capacitance

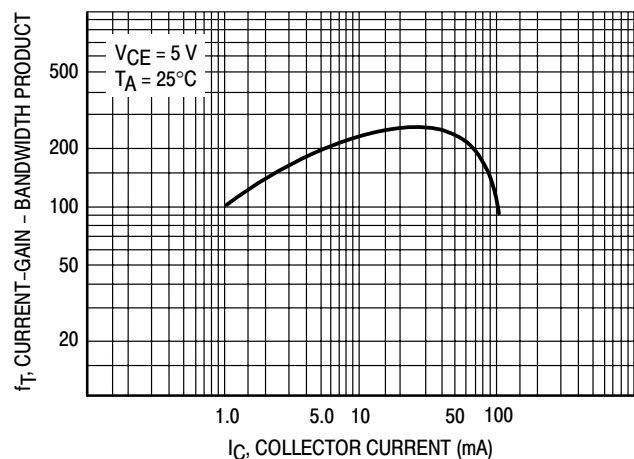

Figure 12. Current-Gain - Bandwidth Product