

RoHS Compliant Product
A suffix of "-C" specifies halogen and lead free

FEATURES

- Epitaxial Planar die construction
- Complementary NPN Type Available MMBT2222A-C
- Ideal for Medium Power Amplification and Switching

SOT-23

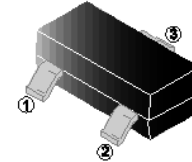

MARKING

2F

PACKAGE INFORMATION

Package	MPQ	Leader Size
SOT-23	3K	7 inch

ORDER INFORMATION

Part Number	Type
MMBT2907A-C	Lead (Pb)-free and Halogen-free

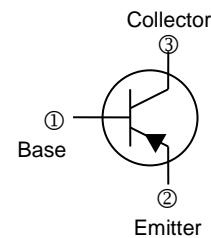

ABSOLUTE MAXIMUM RATINGS (T_A=25°C unless otherwise noted)

Parameter	Symbol	Ratings	Unit
Collector-Base Voltage	V _{CBO}	-60	V
Collector-Emitter Voltage	V _{CEO}	-60	V
Emitter-Base Voltage	V _{EBO}	-5	V
Collector Current	I _C	-600	mA
Power Dissipation	P _D	250	mW
Thermal Resistance from Junction-Ambient	R _{θJA}	500	°C/W
Junction, Storage Temperature Range	T _J , T _{STG}	150, -55~150	°C

ELECTRICAL CHARACTERISTICS ($T_A=25^\circ\text{C}$ unless otherwise noted)

Parameter	Symbol	Min.	Typ.	Max.	Unit	Test Conditions
Collector-Base Breakdown Voltage	$V_{(BR)CBO}$	-60	-	-	V	$I_C = -10\mu\text{A}, I_E = 0$
Collector-Emitter Breakdown Voltage	$V_{(BR)CEO}$	-60	-	-	V	$I_C = -10\text{mA}, I_B = 0$
Emitter-Base Breakdown Voltage	$V_{(BR)EBO}$	-5	-	-	V	$I_E = -10\mu\text{A}, I_C = 0$
Collector Cut-off Current	I_{CBO}	-	-	-100	nA	$V_{CB} = -50\text{V}, I_E = 0$
Collector Cut-off Current	I_{CEX}	-	-	-50		$V_{CE} = -30\text{V}, V_{BE} = -0.5\text{V}$
DC Current Gain	h_{FE}	75	-	-		$V_{CE} = -10\text{V}, I_C = -0.1\text{mA}$
		100	-	-		$V_{CE} = -10\text{V}, I_C = -1\text{mA}$
		100	-	-		$V_{CE} = -10\text{V}, I_C = -10\text{mA}$
		100	-	300		$V_{CE} = -10\text{V}, I_C = -150\text{mA}$
		50	-	-		$V_{CE} = -10\text{V}, I_C = -500\text{mA}$
Collector-Emitter Saturation Voltage	$V_{CE(sat)}$	-	-	-0.4	mV	$I_C = -150\text{mA}, I_B = -15\text{mA}$
		-	-	-1.6		$I_C = -500\text{mA}, I_B = -50\text{mA}$
Base-Emitter Saturation Voltage	$V_{BE(sat)}$	-	-	-1.3	V	$I_C = -150\text{mA}, I_B = -15\text{mA}$
		-	-	-2.6		$I_C = -500\text{mA}, I_B = -50\text{mA}$
Transition Frequency	f_T	-	200	-	MHz	$V_{CE} = -20\text{V}, I_C = -50\text{mA}, f = 100\text{MHz}$
Delay Time	T_d	-	10	-	nS	$V_{CE} = -3\text{V}, I_C = -150\text{mA}, I_{B1} = -15\text{mA}$
Rise Time	T_r	-	40	-		
Storage Time	T_s	-	80	-		
Fall Time	T_f	-	30	-		

TYPICAL CHARACTERISTICS

Static Characteristic

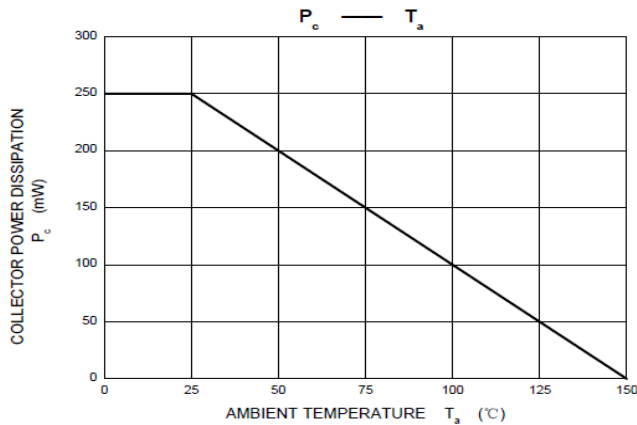
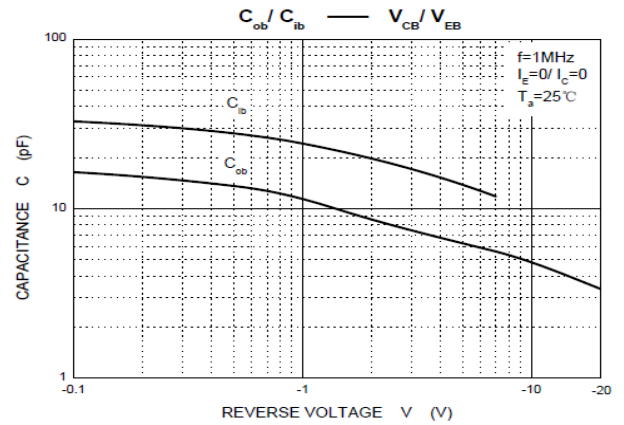
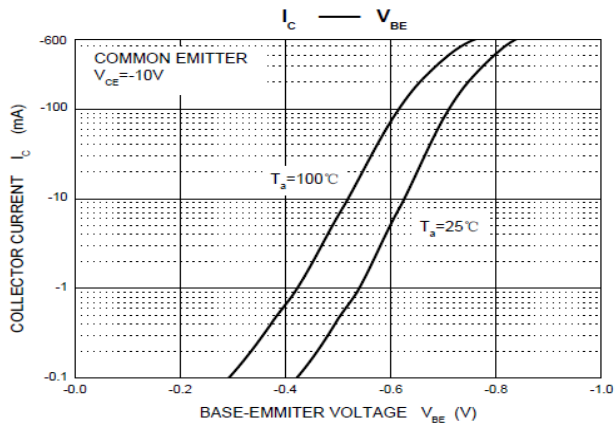
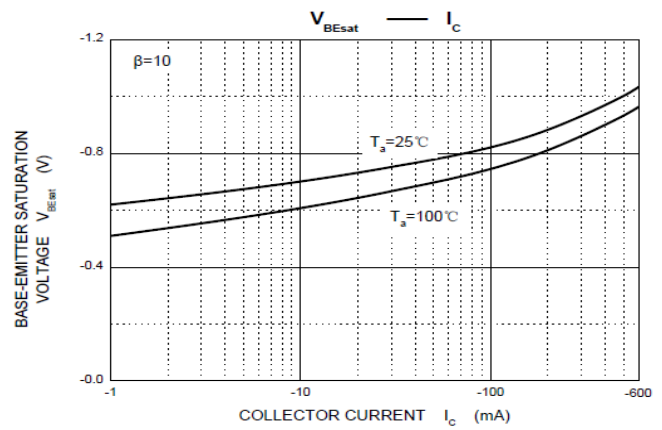
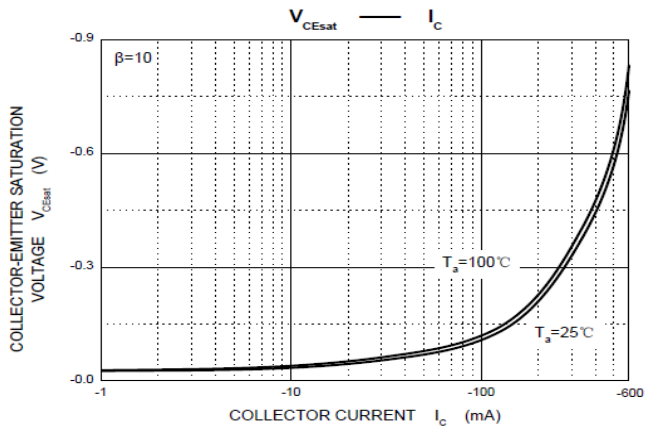
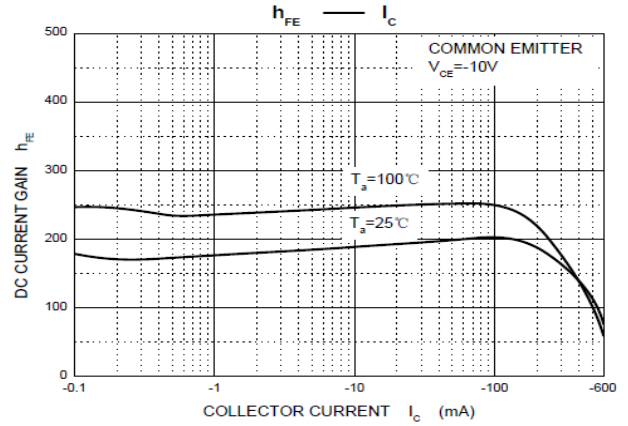
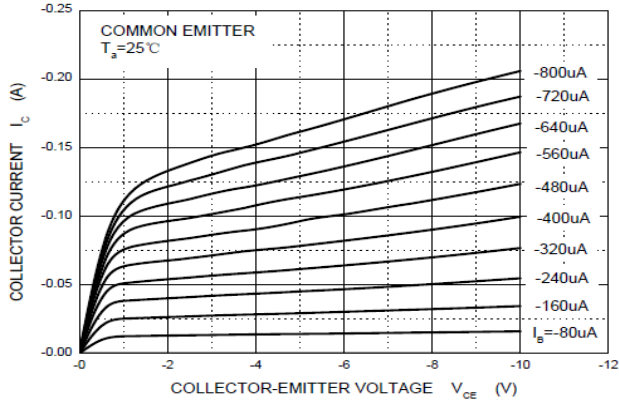

PACKAGE OUTLINE DIMENSIONS

SOT-23

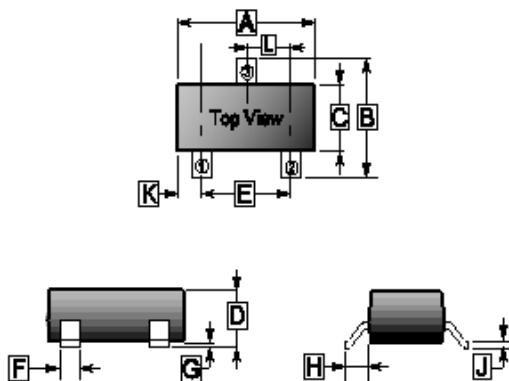

REF.	Millimeter	
	Min.	Max.
A	2.65	3.10
B	2.10	3.00
C	1.10	1.80
D	0.89	1.40
E	1.70	2.30
F	0.28	0.55
G	-	0.18
H	0.55 REF.	
J	0.05	0.26
K	0.60 REF.	
L	0.95 TYP.	

MOUNTING PAD LAYOUT

SOT-23

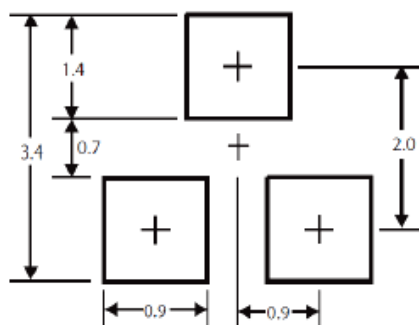

*Dimensions in millimeters