

RoHS Compliant Product

A suffix of "-C" specifies halogen & lead-free

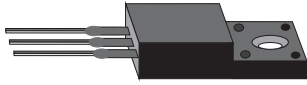

## FEATURES

- \* Low forward voltage drop
- \* High current capability
- \* High reliability
- \* High surge current capability
- \* Epitaxial construction

## MECHANICAL DATA

- \* Case: Molded plastic
- \* Epoxy: UL 94V-0 rate flame retardant
- \* Lead: Lead solderable per MIL-STD-202, method 208 guaranteed
- \* Polarity: As Marked
- \* Mounting position: Any
- \* Weight: 2.24 grams(Approximately)

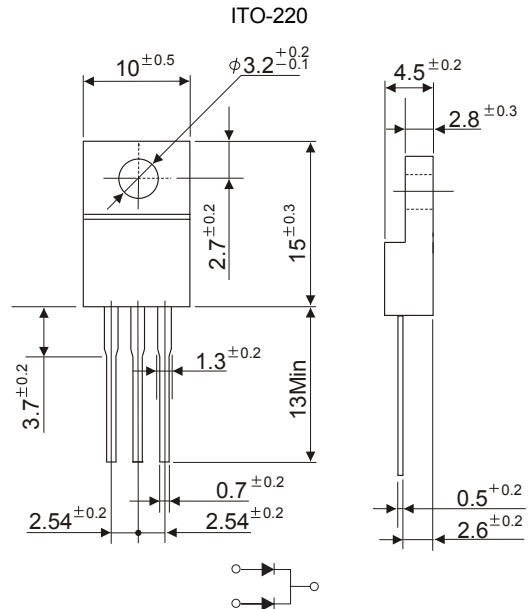

## MAXIMUM RATINGS AND ELECTRICAL CHARACTERISTICS

Rating 25°C ambient temperature unless otherwise specified.  
Single phase half wave, 60Hz, resistive or inductive load.  
For capacitive load, derate current by 20%.

TYPE NUMBER	SYMBOL	SBR3045RF	UNITS
Maximum Recurrent Peak Reverse Voltage	$V_{RRM}$	45	V
Working Peak Reverse Voltage	$V_{RSM}$	45	V
Maximum DC Blocking Voltage	$V_{DC}$	45	V
Maximum Average Forward Rectified Current (Per Leg)	$I_F$	15	A
(Per Device)		30	
Peak Forward Surge Current, 8.3 ms single half sine-wave superimposed on rated load (JEDEC method)	$I_{FSM}$	180	A
Maximum Instantaneous Forward Voltage ( $I_F = 15 \text{ Amps}, T_A = 25^\circ\text{C}$ , per leg)	$V_F$	0.57	V
Maximum Instantaneous Forward Voltage ( $I_F = 15 \text{ Amps}, T_A = 100^\circ\text{C}$ , per leg)		0.52	
Maximum DC Reverse Current $T_a = 25^\circ\text{C}$	$I_R$	0.5	mA
at Rated DC Blocking Voltage (Note3) $T_a = 100^\circ\text{C}$		12	
Typical Junction Capacitance (Note1)	$C_J$	2400	pF
Typical Thermal Resistance (Note2)	$R_{\theta JC}$	4.0	$^\circ\text{C/W}$
Voltage Rate Of Change (Rated $V_R$ )	$dv/dt$	10000	V/us
Operating Temperature Range	$T_J$	-50 ~ +150	$^\circ\text{C}$
Storage Temperature Range	$T_{STG}$	-65 ~ +175	$^\circ\text{C}$

NOTES:

1. Measured at 1MHz and applied reverse voltage of 5.0V D.C.
2. Thermal Resistance Junction to Case.
3. Pulse Test : Pulse Width = 300us, Duty Cycle  $\leq 2.0\%$ .

RATING AND CHARACTERISTIC CURVES

Typical Forward Current Derating Curve

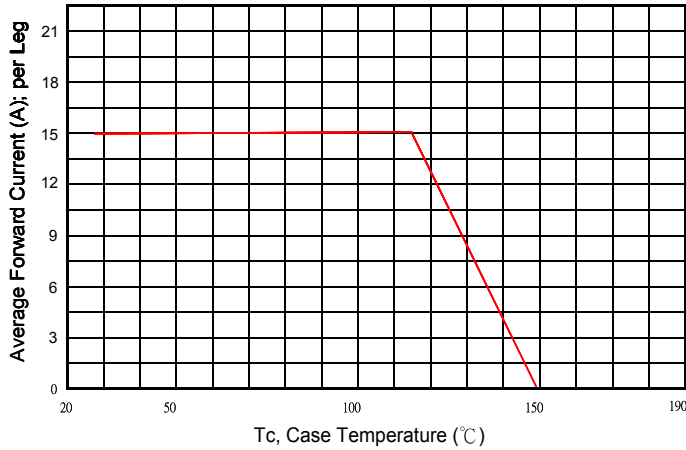

Typical Forward Characteristic

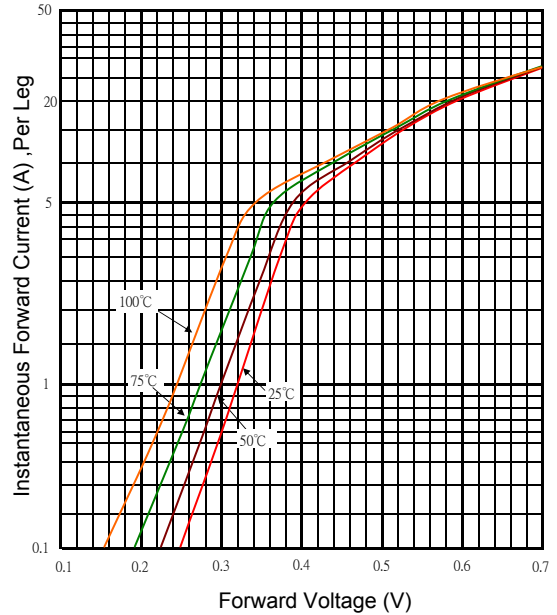

Typical Junction Capacitance

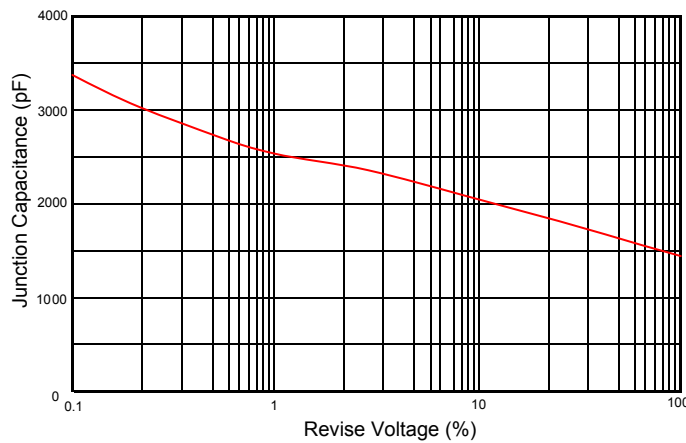

Typical Reverse Characteristic

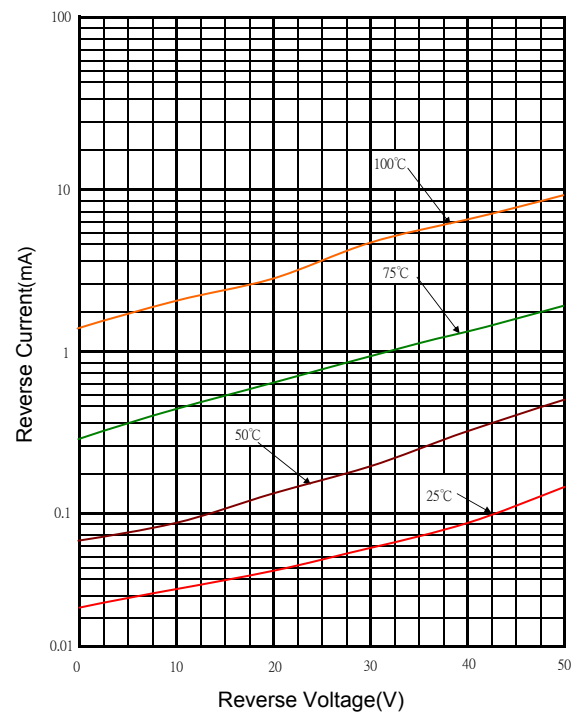

Maximum Non- Repetitive Forward Surge Current

