

RoHS Compliant Product

A suffix of "-C" specifies halogen-free and RoHS Compliant

FEATURES

- Heatsink Structure
- Low Profile, Typical Thickness 0.8mm
- Super Low V_F Schottky barrier diodes
- Moisture Sensitivity: Level 1, Per J-STD-020
- High Temperature Soldering Guaranteed: 260°C/10 Seconds
- AEC-Q101 Qualified

MARKING



↑
Cathode

SOD-123DT

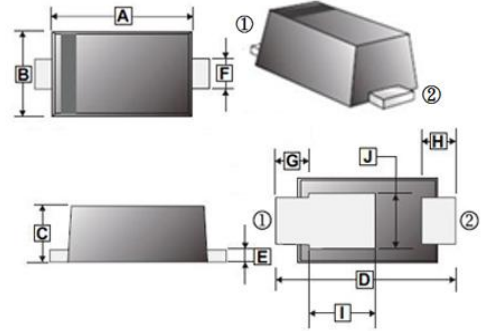

REF.	Millimeter		REF.	Millimeter	
	Min.	Max.		Min.	Max.
A	2.9	3.1	F	0.85	1.05
B	1.9	2.1	G	0.6 REF.	
C	0.75	0.9	H	0.4	0.85
D	3.5	3.9	I	1.66 REF.	
E	0.1	0.25	J	1.3	1.7

PACKAGE INFORMATION

Package	MPQ	Leader Size
SOD-123DT	3K	7 inch

ORDER INFORMATION

Part Number	Type
SM140DTCR	Lead (Pb)-free
SM140DTCR-C	Lead (Pb)-free and Halogen-free

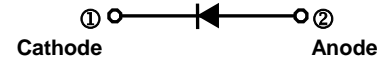

MAXIMUM RATINGS AND ELECTRICAL CHARACTERISTICS ($T_A=25^\circ\text{C}$ unless otherwise specified)

Parameter	Symbol	Part Number	Unit	
Maximum Repetitive Peak Reverse Voltage	V_{RRM}	40	V	
Maximum RMS Voltage	V_{RMS}	28		
Maximum DC Blocking Voltage	V_{DC}	40		
Minimum Breakdown Voltage @ $I_R=1\text{mA}$	V_{BR}	40		
Maximum Average Forward Rectified Current	I_F	1	A	
Peak Forward Surge Current @ 8.3ms Single Half Sine-Wave Superimposed on Rate Load	I_{FSM}	30	A	
Rating for Fusing ($t<8.3\text{ms}$)	I^2t	4	A^2S	
Maximum Instantaneous Forward Voltage	V_F	$I_F=1\text{A}, T_A=25^\circ\text{C}$	0.5	V
		$I_F=1\text{A}, T_A=75^\circ\text{C}$	0.5	
Maximum DC Reverse Current @ DC Blocking Voltage	I_R	$T_A=25^\circ\text{C}$	50	μA
		$T_A=75^\circ\text{C}$	1	mA
Typical Junction Capacitance	C_J	51.2	pF	
Typical Thermal Resistance from Junction to Ambient ¹	$R_{\theta JA}$	65	$^\circ\text{C}/\text{W}$	
Typical Thermal Resistance from Junction to Case ²	$R_{\theta JC}$	35		
Typical Thermal Resistance from Junction to Lead ¹	$R_{\theta JL}$	9		
Operating Junction and Storage Temperature	T_J, T_{STG}	-55~150	$^\circ\text{C}$	

Notes:

1. The thermal resistance from junction to ambient or lead, mounted on P.C.B with 5x5mm copper pads, 2 OZ, FR4 PCB.
2. The thermal resistance from junction to case, mounted on P.C.B with recommended copper pads, 2 OZ, FR4 PCB.

CHARACTERISTIC CURVES

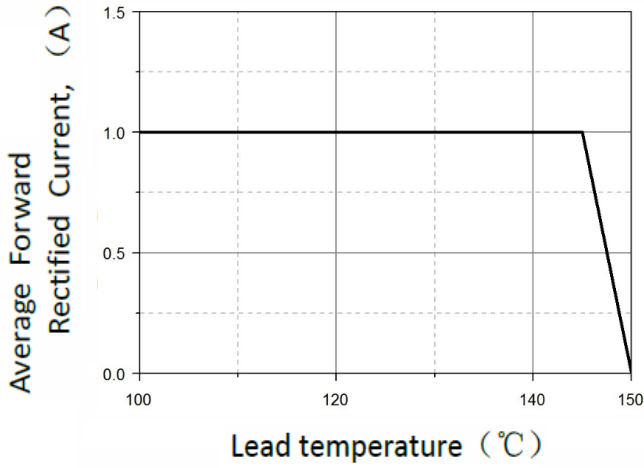

Figure 1. Forward Current Derating Curve

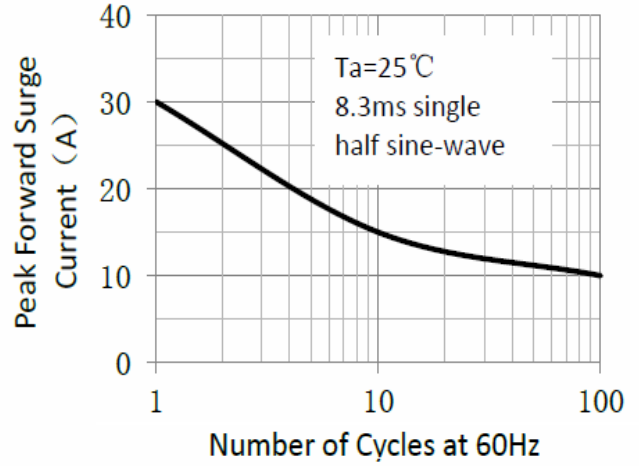

Figure 2. Maximum Non-Repetitive Peak Forward Surge Current

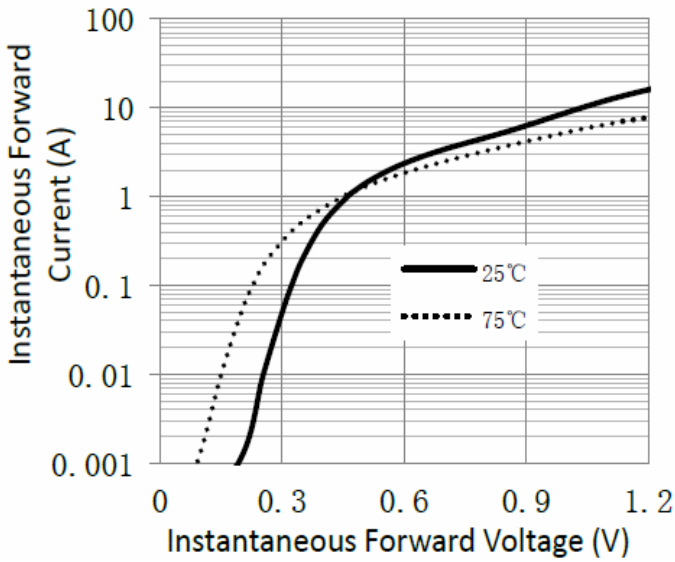

Figure 3. Typical Instantaneous Forward Characteristics

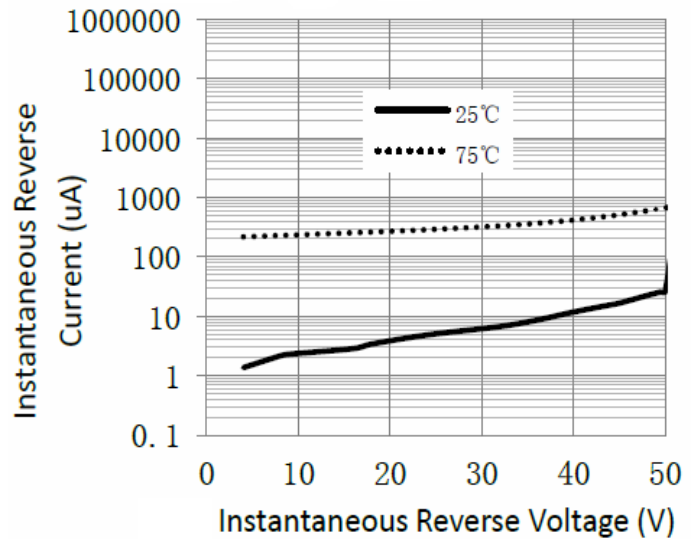

Figure 4. Typical Reverse Characteristics

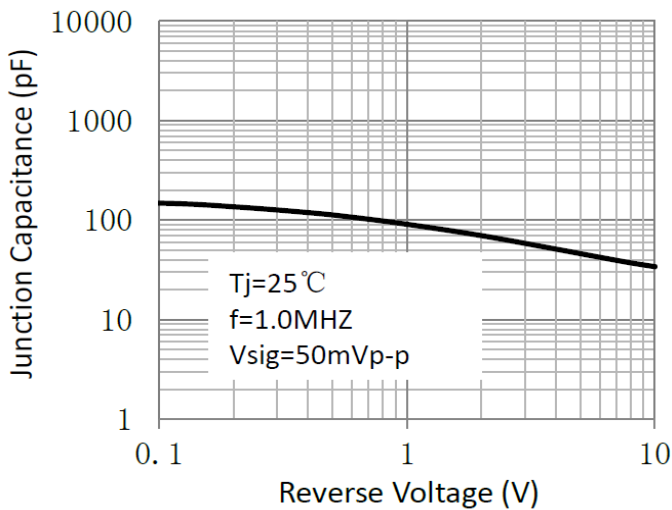

Figure 5. Typical Junction Capacitance