

RoHS Compliant Product

A suffix of "-C" specifies halogen & lead-free

FEATURES

- Ultra-Small Surface Mount Package
- Fast Switching
- PN Junction Guard Ring for Transient and ESD Protection

MECHANICAL DATA

- Case: SOT-523, Molded Plastic
- Terminals: Solderable per MIL-STD-202, Method 208
- Polarity: See Diagrams Below
- Weight: 0.004 grams (approx.)
- Mounting Position: Any

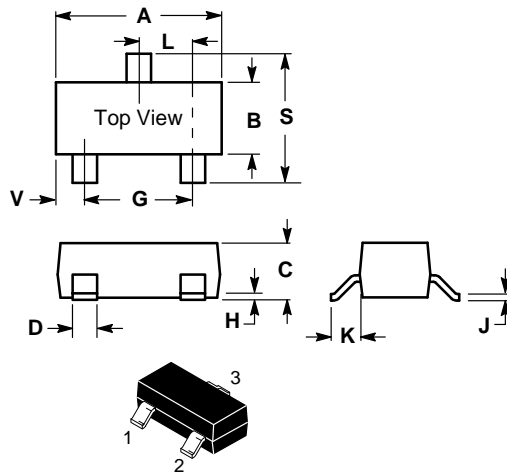

SOT-523		
Dim	Min	Max
A	1.500	1.700
B	0.780	0.820
C	0.800	0.820
D	0.280	0.320
G	0.900	1.100
H	0.000	0.100
J	0.100	0.200
K	0.350	0.410
L	0.490	0.510
S	1.500	1.700
V	0.280	0.320
All Dimension in mm		

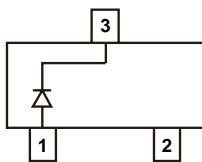

BAT54T Marking: L1

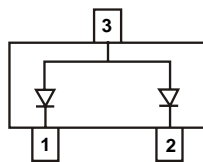

BAT54AT Marking: L2

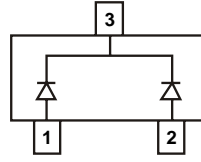

BAT54CT Marking: L3

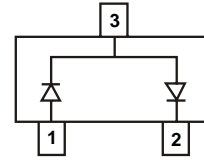

BAT54ST Marking: L4

MAXIMUM RATINGS ($T_J = 125^\circ\text{C}$ unless otherwise noted)

Rating	Symbol	Value	Unit
Reverse Voltage	V_R	30	Volts
Forward Power Dissipation @ $T_A = 25^\circ\text{C}$ Derate above 25°C	P_F	150 4.2	mW mW/ $^\circ\text{C}$
Forward Current (DC)	I_F	200 Max	mA
Junction Temperature	T_J	125 Max	$^\circ\text{C}$
Storage Temperature Range	T_{stg}	-55 to +150	$^\circ\text{C}$

ELECTRICAL CHARACTERISTICS ($T_A = 25^\circ\text{C}$ unless otherwise noted) (EACH DIODE)

Characteristic	Symbol	Min	Typ	Max	Unit
Reverse Breakdown Voltage ($I_R = 10 \mu\text{A}$)	$V_{(BR)R}$	30	—	—	Volts
Total Capacitance ($V_R = 1.0 \text{ V}$, $f = 1.0 \text{ MHz}$)	C_T	—	7.6	10	pF
Reverse Leakage ($V_R = 25 \text{ V}$)	I_R	—	0.5	2.0	μA_{dc}
Forward Voltage ($I_F = 0.1 \text{ mAdc}$)	V_F	—	0.22	0.24	Vdc
Forward Voltage ($I_F = 1.0 \text{ mAdc}$)	V_F	—	0.29	0.32	Vdc
Forward Voltage ($I_F = 10 \text{ mAdc}$)	V_F	—	0.35	0.40	Vdc
Reverse Recovery Time ($I_F = I_R = 10 \text{ mAdc}$, $I_{R(REC)} = 1.0 \text{ mAdc}$) Figure 1	t_{rr}	—	—	5.0	ns
Forward Voltage ($I_F = 30 \text{ mAdc}$)	V_F	—	0.41	0.50	Vdc
Forward Voltage ($I_F = 100 \text{ mAdc}$)	V_F	—	0.52	1.00	Vdc
Forward Current (DC)	I_F	—	—	200	mAdc
Repetitive Peak Forward Current	I_{FRM}	—	—	200	mAdc
Non-Repetitive Peak Forward Current ($t < 1.0 \text{ s}$)	I_{FSM}	—	—	400	mAdc

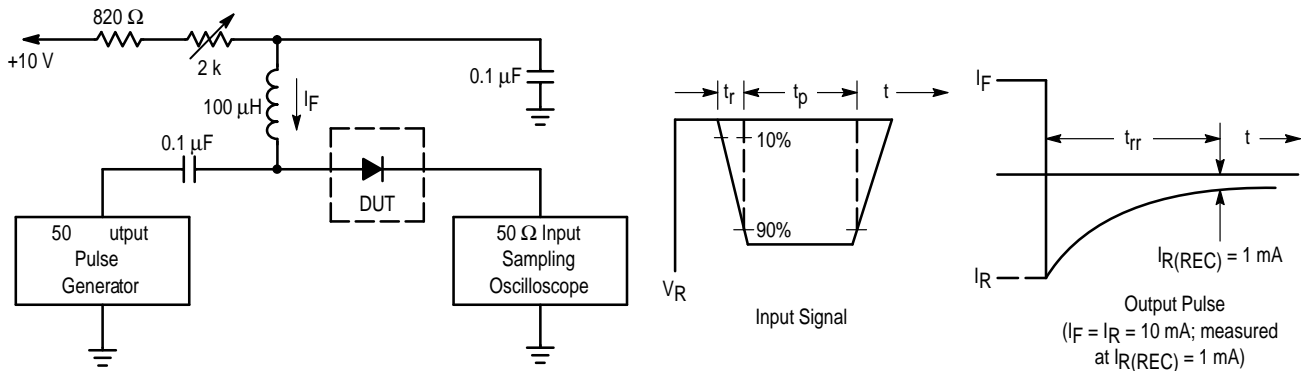

- Notes: 1. A 2.0 kΩ variable resistor adjusted for a Forward Current (I_F) of 10 mA.
2. Input pulse is adjusted so $I_{R(peak)}$ is equal to 10 mA.
3. $t_p \gg t_{rr}$

Figure 1. Recovery Time Equivalent Test Circuit

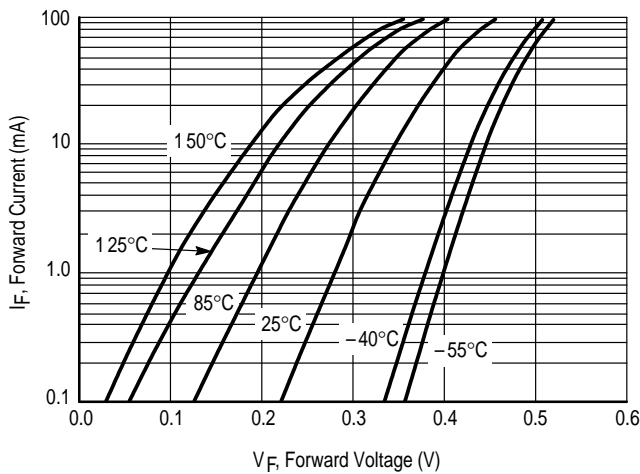

Figure 2. Forward Voltage

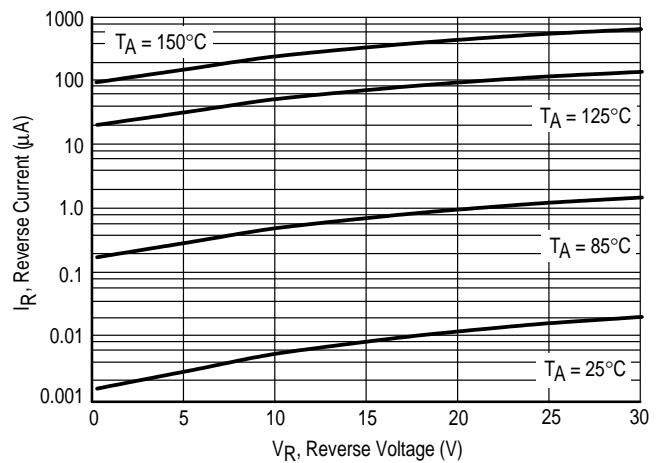

Figure 3. Leakage Current

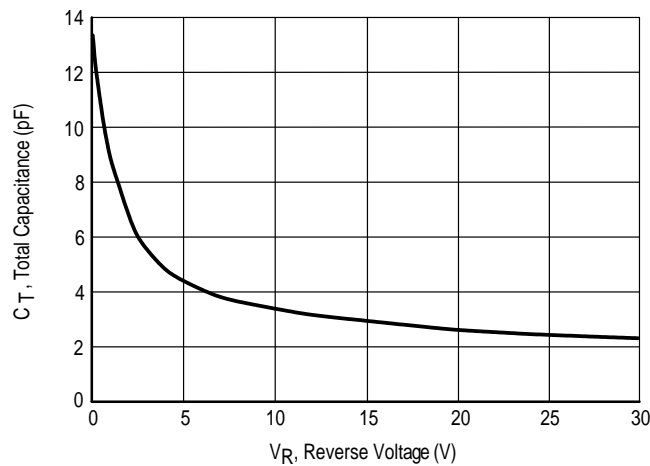

Figure 4. Total Capacitance